

Data distribution – Schemas – Earnings payment reports 2024

Incomes Register Unit

Version history

Version	Date	Description
1.0	22/05/2023	<p>Published a version of the document containing the 2024 changes to the data contents. The changes apply when the payment date of the income is on 1 January 2024 or later.</p> <p>Removed Payer's details may include access-restricted data (SensitiveInfoIncluded) data from the data group Other payer details (PayerOther).</p> <p>Removed Income earner's details may include access-restricted data (SensitiveInfoIncluded) data from the data group Other details (IncomeEarnerOther).</p> <p>Removed Representative's details may include access-restricted data (SensitiveInfoIncluded) data from the data group Representative (Representative).</p> <p>Removed Principal's details may include access-restricted data (SensitiveInfoIncluded) data from the data group Principal (ServiceRecipient).</p> <p>Added a new processing rule "Address information under an access restriction to personal data will not be shared" for the following data groups:</p> <ul style="list-style-type: none"> • Payer's address (Address) • Income earner's addresses (Addresses) • Representative's address (Address) • Principal's address (ServiceRecipientAddress)
1.1	11/09/2023	<p>Added a processing rule for the Payer identifiers (PayerIds) data in the Payer's identifier (Id) data group:</p> <ul style="list-style-type: none"> • A payer can have up to three identifiers.



CONTENTS

1	General	6
1.1	Schema	6
1.2	Character set	6
1.3	Dates and times.....	7
1.4	Document reading instructions.....	8
2	Earnings payment reports (WageReportsFromIR)	9
2.1	Record subscription details (Subscription)	14
2.2	Query details (Query).....	16
2.3	Query summary data (Summary).....	17
2.4	Message-level errors (MessageErrors).....	18
2.5	Record-level errors (DeliveryErrors)	19
2.6	Reports data (Reports).....	20
2.7	Record data (DeliveryData)	22
2.8	Pay period (PaymentPeriod)	25
2.9	Contact persons for the record (ContactPersons)	26
2.10	Payer details (Payer)	27
2.11	Payer identifiers (PayerIds)	28
2.12	Basic payer details (PayerBasic)	30
2.13	Payer's address (Address)	31
2.14	Payer's suborganisations (SubOrgs)	33
2.15	Other payer details (PayerOther).....	34
2.16	Substitute payer (SubstitutePayer)	35
2.17	Service data (ReportData).....	37
2.18	Income earner details (IncomeEarner)	39
2.19	Income earner identifiers (IncomeEarnerIds).....	41
2.20	Basic income earner details (IncomeEarnerBasic)	42
2.21	Income earner's addresses (Addresses).....	43
2.22	Income earner's suborganisations (SubOrgs)	45
2.23	Employment relationship data (Employment).....	46
2.24	Occupation (Professions)	49



2.25 Employment registration (EmploymentRegs).....	50
2.26 Place of business (PlaceOfBusiness).....	51
2.27 Earnings-related pension insurance (PensionInsurance).....	52
2.28 Occupational accident insurance (AccidentInsurance).....	54
2.29 Insurance exceptions (InsuranceExceptions).....	56
2.30 International situations (InternationalData).....	57
2.31 Other details (IncomeEarnerOther).....	59
2.32 Income types (Transactions).....	61
2.33 General details on the income type (TransactionBasic).....	63
2.34 Insurance information (InsuranceData).....	65
2.35 Earnings periods (EarningPeriods).....	66
2.36 Unit of the wages (UnitWages).....	67
2.37 Car benefit (CarBenefit).....	68
2.38 Meal benefit (MealBenefit).....	69
2.39 Other fringe benefit (Otherbenefit).....	70
2.40 Seafarer's income (SailorIncome).....	71
2.41 Additional details on recovery (RecoveryData).....	72
2.42 Daily allowance (DailyAllowance).....	74
2.43 Kilometre allowance (tax-exempt) (KmAllowance).....	75
2.44 Six-month rule (SixMonthRule).....	76
2.45 Details on foreign leased workforce (ForeignLeasedWork).....	77
2.46 Representative (Representative).....	78
2.47 Finnish employer (FinServiceRecipient).....	81
2.48 Stay periods in Finland (StayPeriodInFinland).....	83
2.49 Work periods in Finland (WorkPeriodsInFinland).....	84
2.50 Countries of work (WorkCountries).....	85
2.51 Districts of work (WorkMunicipalities).....	87
2.52 Address in country of work (WorkCountryAddress).....	88
2.53 Principal (ServiceRecipient).....	90
2.54 Stay periods in country of work (StayPeriodsAbroad).....	93
2.55 Work periods abroad (WorkPeriodsAbroad).....	94
2.56 Other remunerations and benefits (Remunerations).....	95
2.57 Absences (Absence).....	96
2.58 Unpaid absence (UnpaidAbsence).....	97

2.59 Paid absence (PaidAbsence) 98

1 GENERAL

1.1 Schema

Earnings payment reports are distributed from the Incomes Register using the **WageReportsFromIR** schema.

The namespaces of the schema are as follows:

File name	Prefix	Namespace
	xmlns:xs	http://www.w3.org/2001/XMLSchema
WageReportsFromIR.xsd	xmlns:wrfir	http://www.tulorekisteri.fi/2017/1/WageReportsFromIR
WageReportsFromIRTypes.xsd	xmlns:wrfirt	http://www.tulorekisteri.fi/2017/1/WageReportsFromIRTypes
StatusMessageTypes.xsd	xmlns:smt	http://www.tulorekisteri.fi/2017/1/StatusMessageTypes
IRCommonTypes.xsd	xmlns:irct	http://www.tulorekisteri.fi/2017/1/IRCommonTypes
xmldsig-core-schema.xsd	xmlns:ds	http://www.w3.org/2000/09/xmldsig#

Data distributed from the Incomes Register is identical to that submitted to the Incomes Register. The data user's data access profile is taken into account in the distribution.

1.2 Character set

The schemas of the Incomes Register use UTF-8, which is the default character set of XML. The file must not contain the Byte Order Mark (BOM) character.

The following table presents the requirements for the conversion of special characters appearing in messages.

Character	Description	Presentation format as an entity
&	ampersand	& conversion is mandatory
<	less than	< conversion is mandatory
>	greater than	> conversion is not mandatory, but conforms with best practices
'	apostrophe	' conversion is not mandatory, but conforms with best practices
"	quotation mark	" conversion is not mandatory, but conforms with

		best practices
--	double hyphen	This character must not appear in an XML file
/*	slash asterisk	This character must not appear in an XML file
&#	ampersand hash	This character must not appear in an XML file

A limited character set is allowed for **reference data**. The allowed characters for the reference data listed below are the numbers 0-9, the letters a-z and A-Z and the symbols "_", "-" and ".".

- Record owner's record reference (DeliveryId)
- Payer's report reference (ReportId)
- Subscriber's primary subscription reference (MainSubscriptionId)
- Subscriber's secondary subscription reference (SubscriptionId)
- Sender's message reference (MessageId)

In the following data items, upper and lowercase characters are significant:

- Country codes in all data groups (for example, "DE" is interpreted to be a different code than "De").
- Customer IDs in all data groups (for example, "150172-999H" is interpreted to be a different ID than "150172-999h").

1.3 Dates and times

Dates (data type xs:date) must not include time zone information. Example of a date:

```
<StartDate>2017-05-11</StartDate>
```

Data elements containing times of day (data types xs:dateTime and xs:time) must include the time zone.

Example in the Finnish time zone (standard time, UTC+2):

```
<Timestamp>2017-05-11T08:00:00+02:00</Timestamp>
```

```
<Time>08:00:00+02:00</Time>
```

Example in UTC time (UTC+0):

```
<Timestamp>2017-05-11T6:00:00Z</Timestamp>
```

```
<Time>06:00:00Z</Time>
```



1.4 Document reading instructions

In the document diagrams, the $0 \dots \infty$ marking in the bottom right-hand corner of an element means that the element may appear several times, or not at all. The $1 \dots \infty$ marking means that the element may appear several times, but must always appear at least once. The mandatory elements are highlighted with a solid border line and voluntary elements with a dashed border line.

In the document tables, the mandatory or voluntary nature of the elements is depicted with the following markings:

V/M	Description
V	The element is always voluntary. Data groups and data items marked as voluntary are included in the queried record if they contain data (data has been submitted in a report or it is data generated by the Incomes Register) and are included in the data access profile used to query the record.
M	The element is always included if its "parent element" is included.

In some elements, messages use a limited range of values, i.e. codes. The possible values for these codes are described in the "Codes" and "Codes – Income types" documents. This document refers to the values presented in the codesets using the term "codes".

2 EARNINGS PAYMENT REPORTS (WAGEREPORTSFROMIR)

The general structure of a record containing earnings payment reports distributed from the Incomes Register is as follows:

Data group name	Type	V/M
Record subscription details (Subscription)	wrfirt:Subscription	M
Query details (Query)	wrfirt:Query	V
Query summary data (Summary)	wrfirt:Summary	M
Message-level errors (MessageErrors)	smt:MessageErrors	V
Record-level errors (DeliveryErrors)	smt:DeliveryErrors	V
Reports data (Reports)	wrfirt:Reports	V
Report data (Report)	wrfirt:Report	M
Record data (DeliveryData)	wrfirt:DeliveryData	M
Pay period (PaymentPeriod)	wrfirt:PaymentPeriod	M
Contact persons for the record (ContactPersons)	wrfirt:ContactPersons	V
Payer details (Payer)	wrfirt:Payer	V
Payer identifiers (PayerIds)	wrfirt:PayerIds	V
Basic payer details (PayerBasic)	wrfirt:PayerBasic	V
Payer's address (Address)	wrfirt:Address	V
Payer's suborganisations (SubOrgs)	wrfirt:SubOrgs	V
Other payer details (PayerOther)	wrfirt:PayerOther	V
Substitute payer (SubstitutePayer)	wrfirt:SubstitutePayer	V
Service data (ReportData)	wrfirt:ReportData	M
Income earner details (IncomeEarner)	wrfirt:IncomeEarner	V
Income earner identifiers (IncomeEarnerIds).	wrfirt:IncomeEarnerIds	V
Basic income earner details (IncomeEarnerBasic)	wrfirt:IncomeEarnerBasic	V
Income earner's addresses (Addresses)	wrfirt:Addresses	V
Income earner's suborganisations (SubOrgs)	wrfirt:Suborgs	V
Employment relationship data (Employment)	wrfirt:Employment	V

Data group name	Type	V/M
Occupation (Professions)	wrfirt:Professions	V
Employment registration (EmploymentRegs)	wrfirt:EmploymentRegs	V
Place of business (PlaceOfBusiness)	wrfirt:PlaceOfBusiness	V
Earnings-related pension insurance (PensionInsurance)	wrfirt:PensionInsurance	V
Occupational accident insurance (AccidentInsurance)	wrfirt:AccidentInsurance	V
Insurance exceptions (InsuranceExceptions)	wrfirt:InsuranceException s	V
International situations (InternationalData)	wrfirt:InternationalData	V
Other details (IncomeEarnerOther)	wrfirt:IncomeEarnerOthe r	V
Income types (Transactions)	wrfirt:Transactions	V
Income type details (Transactions)	wrfirt:Transaction	M
General details on the income type (TransactionBasic)	wrfirt:TransactionBasic	V
Insurance information (InsuranceData)	wrfirt:InsuranceData	V
Earnings periods (EarningPeriods)	wrfirt:EarningPeriods	V
Unit of the wages (UnitWages)	wrfirt:UnitWages	V
Car benefit (CarBenefit)	wrfirt:CarBenefit	V
Meal benefit (MealBenefit)	wrfirt:MealBenefit	V
Other fringe benefit (Otherbenefit)	wrfirt:OtherBenefit	V
Seafarer's income (SailorIncome)	wrfirt:SailorIncome	V
Additional details on recovery (RecoveryData)	wrfirt:RecoveryData	V
Daily allowance (DailyAllowance)	wrfirt:DailyAllowance	V
Kilometre allowance (tax-exempt) (KmAllowance)	wrfirt:KmAllowance	V
Six-month rule (SixMonthRule)	wrfirt:SixMonthRule	V
Details on foreign leased workforce (ForeignLeasedWork)	wrfirt:ForeignLeasedWor k	V
Representative (Representative)	wrfirt:Representative	V

Data group name	Type	V/M
Finnish employer (FinServiceRecipient)	wrfirt:FinServiceRecipient	V
Stay periods in Finland (StayPeriodInFinland)	wrfirt:StayPeriodsInFinland	V
Work periods in Finland (WorkPeriodsInFinland)	wrfirt:WorkPeriodsInFinland	V
Countries of work (WorkCountries)	wrfirt:WorkCountries	V
Country of work (WorkCountries)	wrfirt:WorkCountry	M
Districts of work (WorkMunicipalities)	wrfirt:WorkMunicipalities	V
Address in country of work (WorkCountryAddress)	wrfirt:WorkCountryAddress	V
Principal (ServiceRecipient)	wrfirt:ServiceRecipient	V
Stay periods in country of work (StayPeriodsAbroad)	wrfirt: StayPeriodsAbroad	V
Work periods abroad (WorkPeriodsAbroad)	wrfirt: WorkPeriodsAbroad	V
Other remunerations and benefits (Remunerations)	wrfirt: Remunerations	V
Absences (Absence)	wrfirt:Absence	V
Unpaid absence (UnpaidAbsence)	wrfirt:UnpaidAbsence	V
Paid absence (PaidAbsence)	wrfirt:PaidAbsence	V
Signature (Signature)	xsig:SignatureType	M

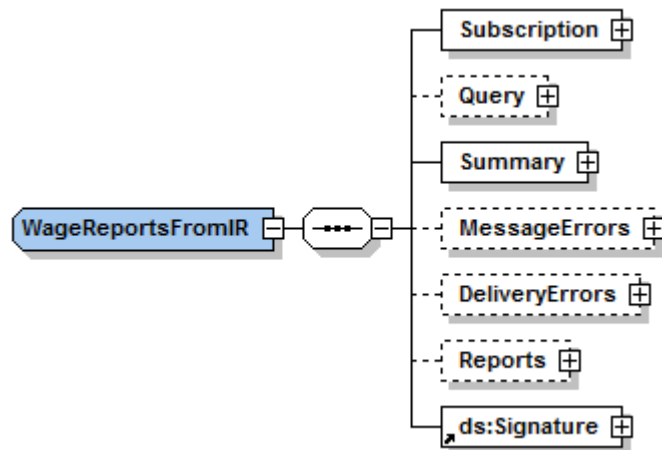

**Data group details:**

Data designation	Type	Allowed values	V/ M	Processing rule
Record subscription details (Subscription)	wrfirt:Subscription		M	This data group is used to distribute information related to a record subscription or a service request.
Query details (Query)	wrfirt:Query		V	This data group is used to distribute information related to a query. The data group will not appear in the response message to a real-time WS service invocation compliant with the DataRequestToIR schema, if a message-level or record-level error was detected during the processing of the service invocation.
Query summary data (Summary)	wrfirt:Summary		M	This data group is used to distribute summary information related to a query.
Message-level errors (MessageErrors)	smt:MessageErrors		V	This data group can only appear in the response message to a real-time WS service invocation compliant with the DataRequestToIR schema.



Data designation	Type	Allowed values	V/ M	Processing rule
Record-level errors (DeliveryErrors)	smt:DeliveryErrors		V	This data group can only appear in the response message to a real-time WS service invocation compliant with the DataRequestToIR schema.
Reports data (Reports)	wrfirt:Reports		V	Earnings payment reports
Signature (Signature)	xsig:SignatureType		M	The electronic signature of the record is delivered in this data group.



2.1 Record subscription details (Subscription)

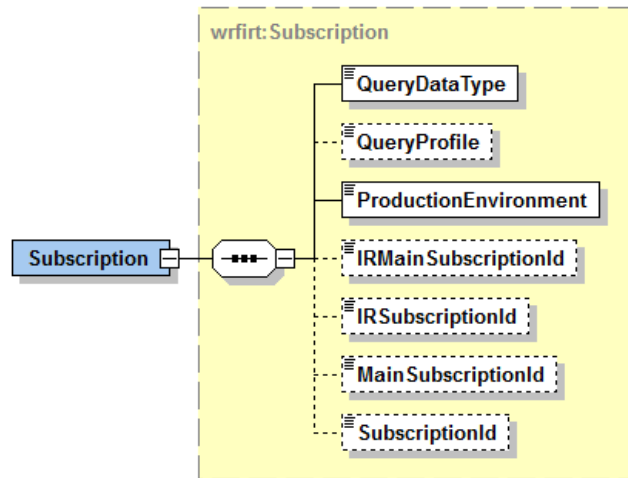

Data group details:

Data designation	Type	Allowed values	V/ M	Processing rule
Record subscription details (Subscription)	wrfirt:Subscription		M	This data group is used to distribute information related to a record subscription or a service request.
Record type (QueryDataType)	xs:int	Codes: QueryDataType	M	Data submitted in a record subscription or service request.
Data access profile (QueryProfile)	irct:String40		V	Data submitted in a record subscription or service request.
Production environment (ProductionEnvironment)	irct:trueOrFalse	Codes: ProductionEnvironm ent	M	Data submitted in a record subscription or service request.
Incomes Register primary subscription reference (IRMainSubscriptionId)	irct:Guid		V	The Incomes Register primary subscription reference for the primary subscription based on which the record was queried.



Data designation	Type	Allowed values	V/ M	Processing rule
				The data is not included in the response message to a real-time WS service invocation compliant with the DataRequestToIR schema.
Incomes Register secondary subscription reference (IRSubscriptionId)	irct:Guid		V	The Incomes Register secondary subscription reference for the secondary subscription based on which the record was queried. The data is not included in the response message to a real-time WS service invocation compliant with the DataRequestToIR schema.
Subscriber's primary subscription reference (MainSubscriptionId)	irct:String40		V	The subscriber's primary subscription reference for the primary subscription based on which the record was queried. The data is not included in the response message to a real-time WS service invocation compliant with the DataRequestToIR schema.
Subscriber's secondary subscription reference (SubscriptionId)	irct:String40		V	The subscriber's secondary subscription reference for the secondary subscription based on which the record was queried. The data is not included in the response message to a real-time WS service invocation compliant with the DataRequestToIR schema.



2.2 Query details (Query)

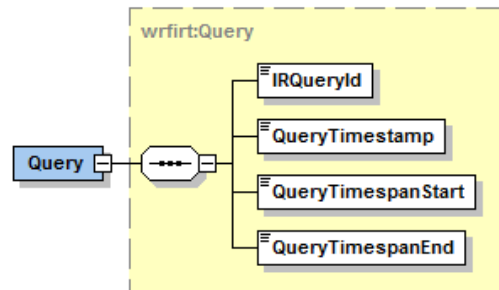

Data group details:

Data designation	Type	Allowed values	V/ M	Processing rule
Query details (Query)	wrfirt:Query		V	This data group is used to distribute information related to a query.
Incomes Register query reference (IRQueryId)	irct:Guid		M	The reference assigned by the Incomes Register to the queried record. The reference uniquely identifies every record queried from the Incomes Register.
Query time (QueryTimestamp)	xs:dateTime		M	The date and time when the record was queried.
Start of the query time range for changes (QueryTimespanStart)	xs:dateTime		M	The record includes data changed since this date and time.
End of the query time range for changes (QueryTimespanEnd)	xs:dateTime		M	The record includes data changed up to this date and time (excluding end time).



2.3 Query summary data (Summary)

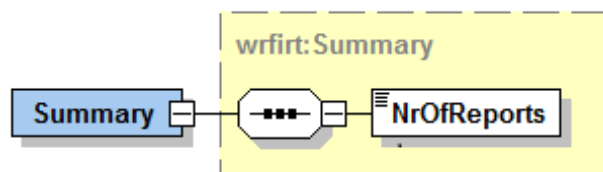

Data group details:

Data designation	Type	Allowed values	V/ M	Processing rule
Query summary data (Summary)	wrfirt:Summary		M	This data group is used to distribute summary information related to a query.
The number of queried items (NrOfReports)	xs:int		M	The number of queried earnings payment reports.

2.4 Message-level errors (MessageErrors)

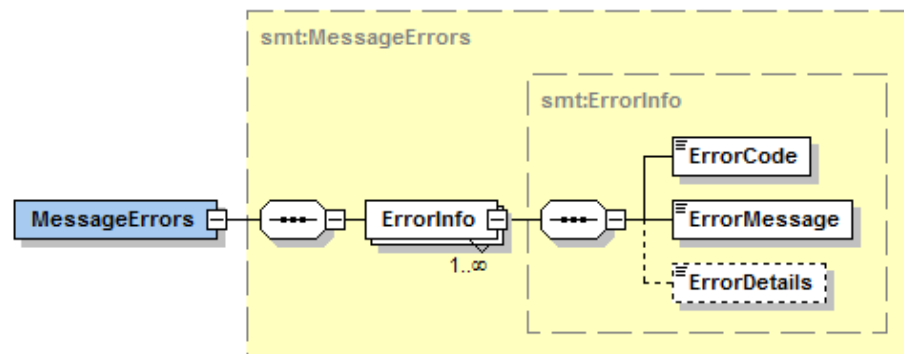

Data group details:

Data designation	Type	Allowed values	V/ M	Processing rule
Message-level errors (MessageErrors)	smt:MessageErrors		V	This data group is used to return technical and authorisation errors. This data group can only appear in the response message to a real-time WS service invocation compliant with the DataRequestToIR schema.
Error information (ErrorInfo)	smt:ErrorInfo		M	There may be several errors.
Error code (ErrorCode)	irct:String20		M	The error code is returned in this element.
Error code description (ErrorMessage)	irct:String500		M	A description of the error code is returned in this element.
Error details (ErrorDetails)	irct:String500		V	Allocation and identifying information for the error is returned in this element.



2.6 Reports data (Reports)

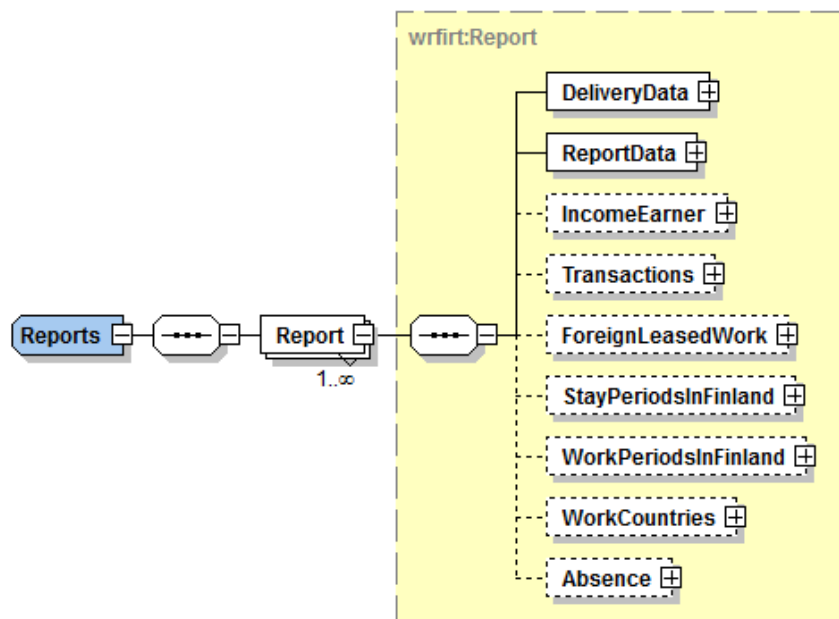

Data group details:

Data designation	Type	Allowed values	V/ M	Processing rule
Reports data (Reports)	wrfirt:Reports		V	This data group is used to return the earnings payment reports queried to the record. Data groups or data items belonging to this data group and marked as voluntary are returned if they were submitted in the report, and are included in the data access profile used to query the record.
Report data (Report)	wrfirt:Report		M	There may be several reports.
Record data (DeliveryData)	wrfirt:DeliveryData		M	

Data designation	Type	Allowed values	V/ M	Processing rule
Service data (ReportData)	wrfirt:ReportData		M	
Income earner details (IncomeEarner)	wrfirt:IncomeEarner		V	
Income types (Transactions)	wrfirt:Transactions		V	
Details on foreign leased workforce (ForeignLeasedWork)	wrfirt:ForeignLeasedWork		V	
Stay periods in Finland (StayPeriodInFinland)	wrfirt:StayPeriodsInFinland		V	
Work periods in Finland (WorkPeriodsInFinland)	wrfirt:WorkPeriodsInFinland		V	
Countries of work (WorkCountries)	wrfirt:WorkCountries		V	
Absences (Absence)	wrfirt:Absence		V	

2.7 Record data (DeliveryData)

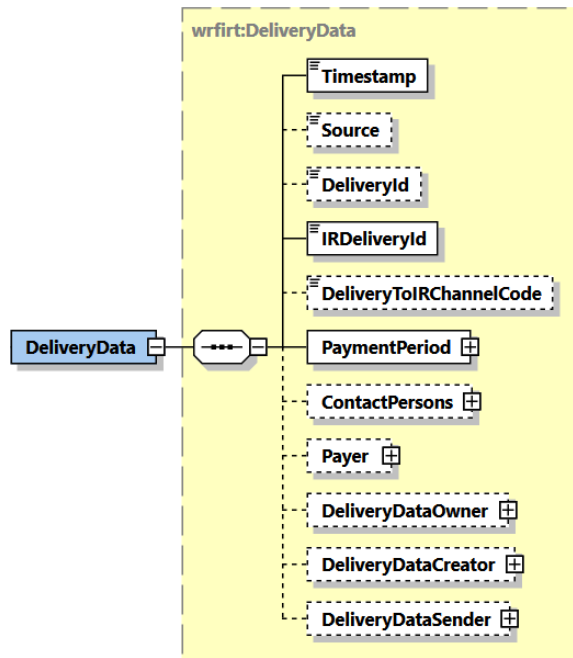

Data group details:

Data designation	Type	Allowed values	V/ M	Processing rule
Record data (DeliveryData)	wrfirt:DeliveryData		M	Data groups or data items belonging to this data group and marked as voluntary are returned if they were submitted in the report, and are included in the data access profile used to query the record.
Time of record creation (Timestamp)	xs:dateTime		M	
Data source (Source)	irct:String30		V	

Data designation	Type	Allowed values	V/ M	Processing rule
Record owner's (payer's) record reference (DeliveryId)	irct:String40		V	
Incomes Register record reference (IRDeliveryId)	irct:Guid		M	
Record delivery channel (DeliveryToIRChannelCode)	xs:int	Codes: DeliveryToIRChannel Code	V	
Pay period (PaymentPeriod)	wrfirt:PaymentPeriod		M	
Contact persons for the record (ContactPersons)	wrfirt:ContactPersons		V	
Payer details (Payer)	wrfirt:Payer		V	
Record owner (DeliveryDataOwner)	wrfirt:Id		V	
Identifier type (Type)	xs:int	Codes: IdType	V	
Identifier (Code)	irct:String30		V	
Country code (CountryCode)	irct:String2	A two-character code in accordance with the ISO 3166 country codes. If the country is unknown, the value is "99".	V	
Country name (CountryName)	irct:String70		V	
Record creator (DeliveryDataCreator)	wrfirt:Id		V	
Identifier type (Type)	xs:int	Codes: IdType	V	
Identifier (Code)	irct:String30		V	
Country code (CountryCode)	irct:String2	A two-character code in accordance with the ISO 3166 country codes.	V	



Data designation	Type	Allowed values	V/ M	Processing rule
		If the country is unknown, the value is "99".		
Country name (CountryName)	irct:String70		V	
Record submitter (DeliveryDataSender)	wrfirt:Id		V	
Identifier type (Type)	xs:int	Codes: IdType	V	
Identifier (Code)	irct:String30		V	
Country code (CountryCode)	irct:String2	A two-character code in accordance with the ISO 3166 country codes. If the country is unknown, the value is "99".	V	
Country name (CountryName)	irct:String70		V	

2.8 Pay period (PaymentPeriod)

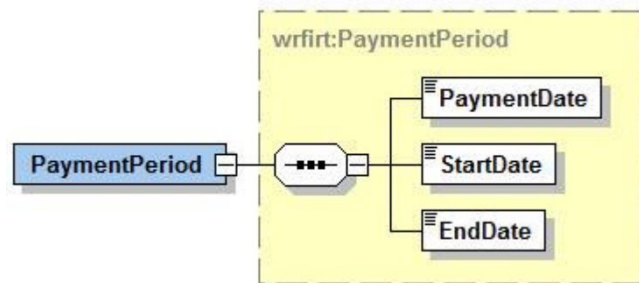

Data group details:

Data designation	Type	Allowed values	V/ M	Processing rule
Pay period (PaymentPeriod)	wrfirt:PaymentPeriod		M	
Date of payment or other report (PaymentDate)	xs:date		M	
Start date (StartDate)	xs:date		M	
End date (EndDate)	xs:date		M	



2.9 Contact persons for the record (ContactPersons)

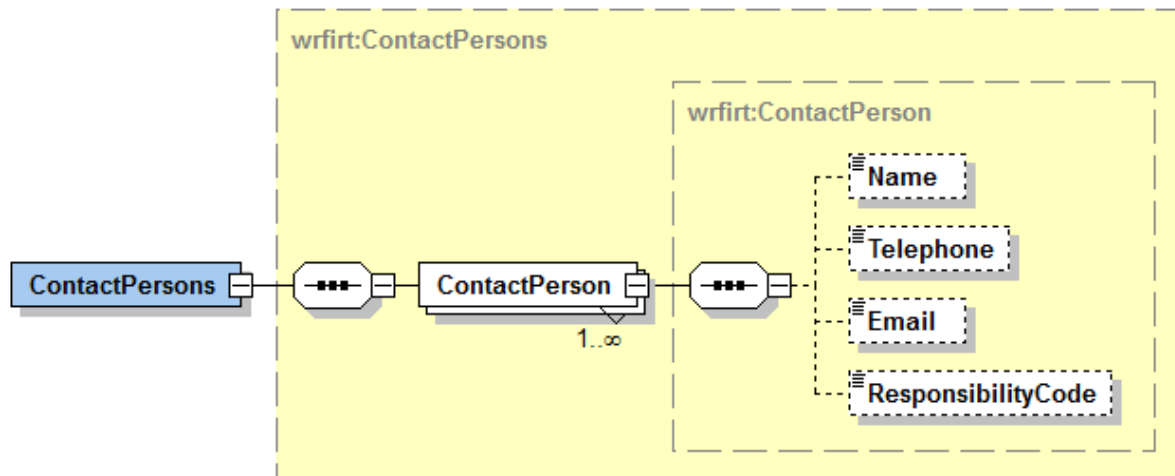

Data group details:

Data designation	Type	Allowed values	V/ M	Processing rule
Contact persons for the record (ContactPersons)	wrfirt:ContactPersons		V	Data groups or data items belonging to this data group and marked as voluntary are returned if they were submitted in the report, and are included in the data access profile used to query the record.
Contact person for the record (ContactPerson)	wrfirt:ContactPerson		M	There may be several contact persons.
Name (Name)	irct:String200		V	
Telephone number (Telephone)	irct:String40		V	
E-mail address (Email)	irct:String70		V	
Field of responsibility (ResponsibilityCode)	xs:int	Codes: ResponsibilityCode	V	

2.10 Payer details (Payer)

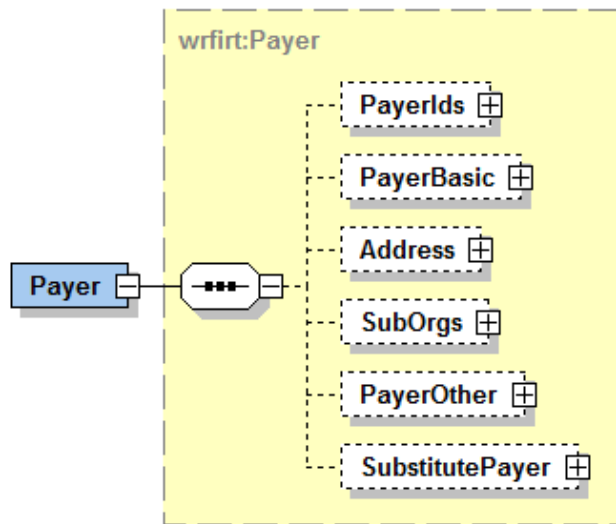

Data group details:

Data designation	Type	Allowed values	V/ M	Processing rule
Payer details (Payer)	wrfirt:Payer		V	Data groups or data items belonging to this data group and marked as voluntary are returned if they were submitted in the report, and are included in the data access profile used to query the record.
Payer identifiers (PayerIds)	wrfirt:PayerIds		V	
Basic payer details (PayerBasic)	wrfirt:PayerBasic		V	
Payer's address (Address)	wrfirt:Address		V	
Payer's suborganisations (SubOrgs)	wrfirt:SubOrgs		V	
Other payer details (PayerOther)	wrfirt:PayerOther		V	
Substitute payer (SubstitutePayer)	wrfirt:SubstitutePayer		V	

2.11 Payer identifiers (PayerIds)

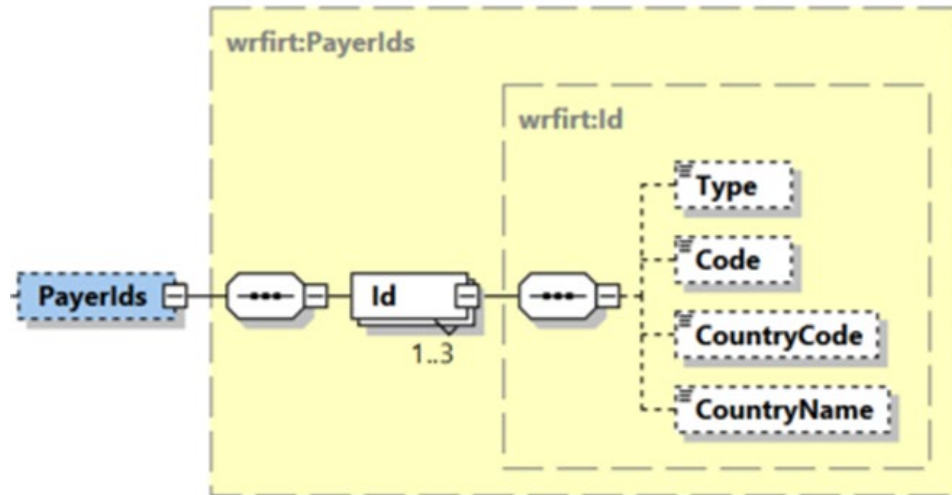

Data group details:

Data designation	Type	Allowed values	V/ M	Processing rule
Payer identifiers (PayerIds)	wrfirt:PayerIds		V	Data groups or data items belonging to this data group and marked as voluntary are returned if they were submitted in the report, and are included in the data access profile used to query the record.
Payer's ID (Id)	wrfirt:Id		M	A payer can have up to three identifiers.
Identifier type (Type)	xs:int	Codes: IdType	V	
Identifier (Code)	irct:String30		V	
Country code (CountryCode)	irct:String2	A two-character code in accordance with the ISO 3166 country codes.	V	



Data designation	Type	Allowed values	V/ M	Processing rule
		If the country is unknown, the value is "99".		
Country name (CountryName)	irct:String70		V	

2.12 Basic payer details (PayerBasic)

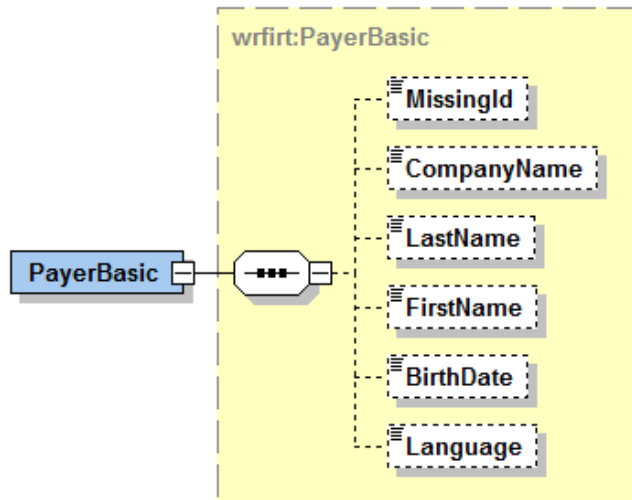

Data group details:

Data designation	Type	Allowed values	V/ M	Processing rule
Basic payer details (PayerBasic)	wrfirt:PayerBasic		V	Data groups or data items belonging to this data group and marked as voluntary are returned if they were submitted in the report, and are included in the data access profile used to query the record.
The payer does not have a customer ID (MissingId)	irct:true	"true"	V	
Company name (CompanyName)	irct:String200		V	
Last name (LastName)	irct:String200		V	
First name (FirstName)	irct:String100		V	
Date of birth (BirthDate)	xs:date		V	
Contact language (Language)	xs:int	Codes: Language	V	



2.13 Payer's address (Address)

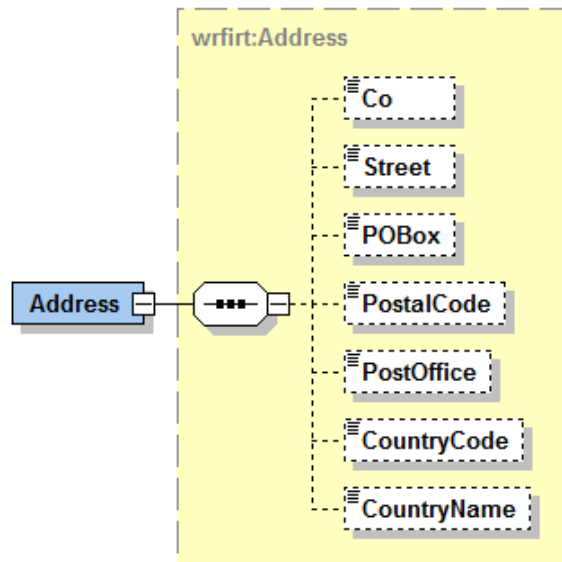

Data group details:

Data designation	Type	Allowed values	V/ M	Processing rule
Payer's address (Address)	wrfirt:Address		V	Data groups or data items belonging to this data group and marked as voluntary are returned if they were submitted in the report, and are included in the data access profile used to query the record. Address information under an access restriction to personal data will not be shared.
c/o (Co)	irct:String70		V	
Street address (Street)	irct:String100		V	
P.O. Box (POBox)	irct:String10		V	

Data designation	Type	Allowed values	V/ M	Processing rule
Postal code (PostalCode)	irct:String20		V	
City (PostOffice)	irct:String200		V	
Country code (CountryCode)	irct:String2	A two-character code in accordance with the ISO 3166 country codes. If the country is unknown, the value is "99".	V	
Country name (CountryName)	irct:String70		V	



2.14 Payer's suborganisations (SubOrgs)

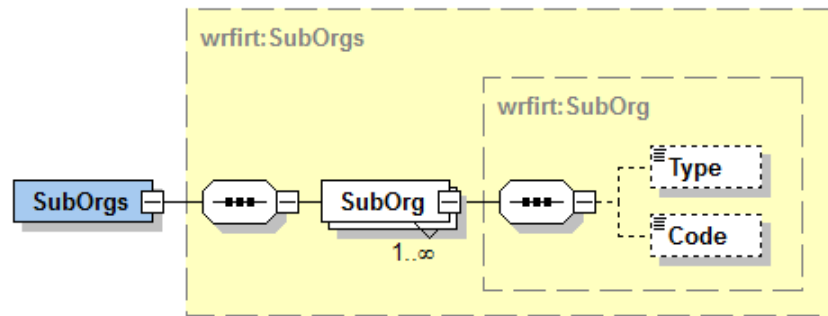

Data group details:

Data designation	Type	Allowed values	V/ M	Processing rule
Payer's suborganisations (SubOrgs)	wrfirt:SubOrgs		V	Data groups or data items belonging to this data group and marked as voluntary are returned if they were submitted in the report, and are included in the data access profile used to query the record.
Payer's suborganisation (SubOrg)	wrfirt:SubOrg		M	A payer can have several suborganisations.
Suborganisation's identifier type (Type)	xs:int	Codes: PayerSubOrgType	V	
Suborganisation identifier (Code)	irct:String20		V	



2.15 Other payer details (PayerOther)

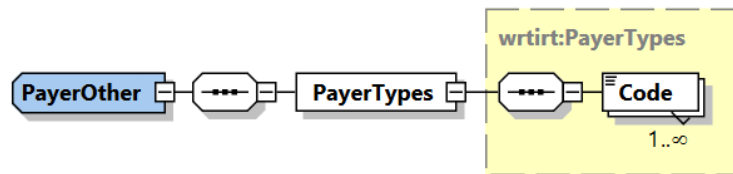

Data group details:

Data designation	Type	Allowed values	V/ M	Processing rule
Other payer details (PayerOther)	wrfirt:PayerOther		V	Data groups or data items belonging to this data group and marked as voluntary are returned if they were submitted in the report, and are included in the data access profile used to query the record.
Payer types (PayerTypes)	wrfirt:PayerTypes		V	
Payer type (Code)	xs:int	Codes: PayerType	M	A payer can have several payer types.



2.16 Substitute payer (SubstitutePayer)

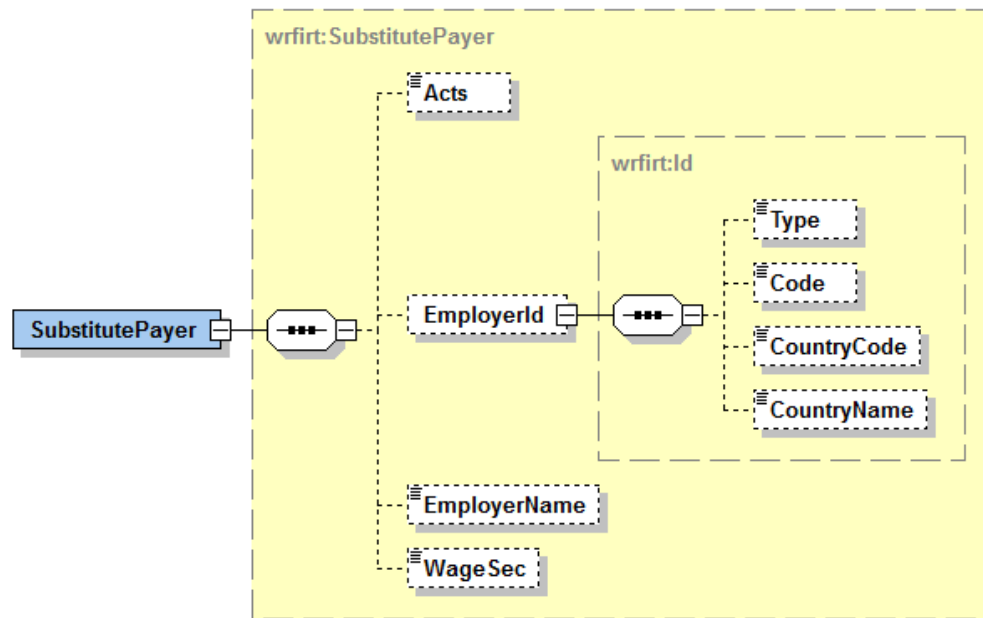

Data group details:

Data designation	Type	Allowed values	V/ M	Processing rule
Substitute payer (SubstitutePayer)	wrfirt:SubstitutePayer		V	Data groups or data items belonging to this data group and marked as voluntary are returned if they were submitted in the report, and are included in the data access profile used to query the record.
Acts as a substitute payer (Acts)	irct:true	"true"	V	
Employer identifier (EmployerId)	wrfirt:Id		V	
Identifier type (Type)	xs:int	Codes: IdType	V	
Identifier (Code)	irct:String30		V	



Data designation	Type	Allowed values	V/ M	Processing rule
Country code (CountryCode)	irct:String2	A two-character code in accordance with the ISO 3166 country codes. If the country is unknown, the value is "99".	V	
Country name (CountryName)	irct:String70		V	
Employer name (EmployerName)	irct:String200		V	
Paid as wage security (WageSec)	irct:true	"true"	V	

2.17 Service data (ReportData)

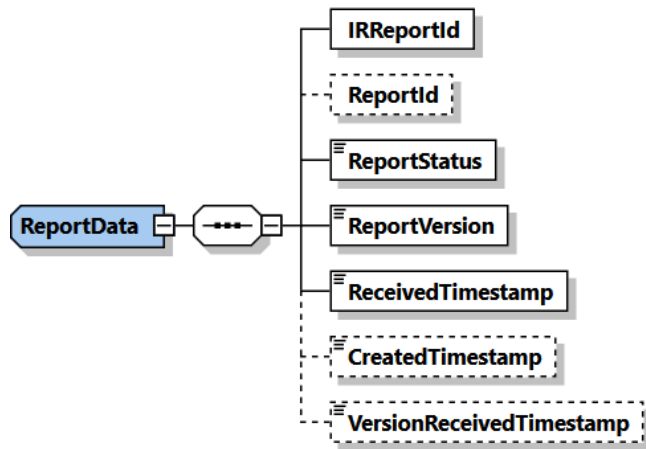

Data group details:

Data designation	Type	Allowed values	V/ M	Processing rule
Service data (ReportData)	wrfirt:ReportData		M	Data groups or data items belonging to this data group and marked as voluntary are returned if they were submitted in the report, and are included in the data access profile used to query the record.
Incomes Register report reference (IRReportId)	irct:Guid		M	
Payer's report reference (ReportId)	irct:String40		V	
Report status (ReportStatus)	xs:int	Codes: ReportStatus	M	
Report version number (ReportVersion)	xs:int		M	

Data designation	Type	Allowed values	V/ M	Processing rule
Reception timestamp of the first version of the report (ReceivedTimestamp)	xs:dateTime		M	The date and time when the first version of the report was received by the Incomes Register.
Report version creation timestamp (CreatedTimestamp)	xs:dateTime		V	The date and time when the report version has been saved in the Incomes Register.
Report version reception timestamp (VersionReceivedTimestamp)	xs:dateTime		V	The date and time when the report version was received by the Incomes Register.

2.18 Income earner details (IncomeEarner)

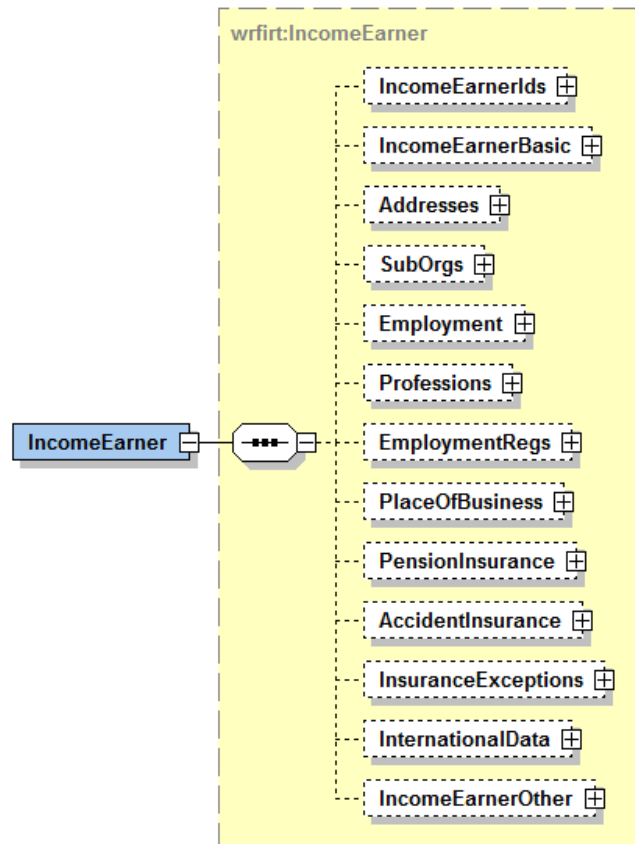

Data group details:

Data designation	Type	Allowed values	V/ M	Processing rule
Income earner details (IncomeEarner)	wrfirt:IncomeEarner		V	Data groups or data items belonging to this data group and marked as voluntary are returned if they were submitted in the report, and are included in the data access profile used to query the record.

Data designation	Type	Allowed values	V/ M	Processing rule
Income earner identifiers (IncomeEarnerIds).	wrfirt:IncomeEarnerIds		V	
Basic income earner details (IncomeEarnerBasic)	wrfirt:IncomeEarnerBasic		V	
Income earner's addresses (Addresses)	wrfirt:Addresses		V	
Income earner's suborganisations (SubOrgs)	wrfirt:SubOrgs		V	
Employment relationship data (Employment)	wrfirt:Employment		V	
Occupation (Professions)	wrfirt:Professions		V	
Employment registration (EmploymentRegs)	wrfirt:EmploymentRegs		V	
Income earner's place of business (PlaceOfBusiness)	wrfirt:PlaceOfBusiness		V	
Earnings-related pension insurance (PensionInsurance)	wrfirt:PensionInsurance		V	
Occupational accident insurance (AccidentInsurance)	wrfirt:AccidentInsurance		V	
Insurance exceptions (InsuranceExceptions)	wrfirt:InsuranceExceptions		V	
International situations (InternationalData)	wrfirt:InternationalData		V	
Other details (IncomeEarnerOther)	wrfirt:IncomeEarnerOther		V	

2.19 Income earner identifiers (IncomeEarnerIds).

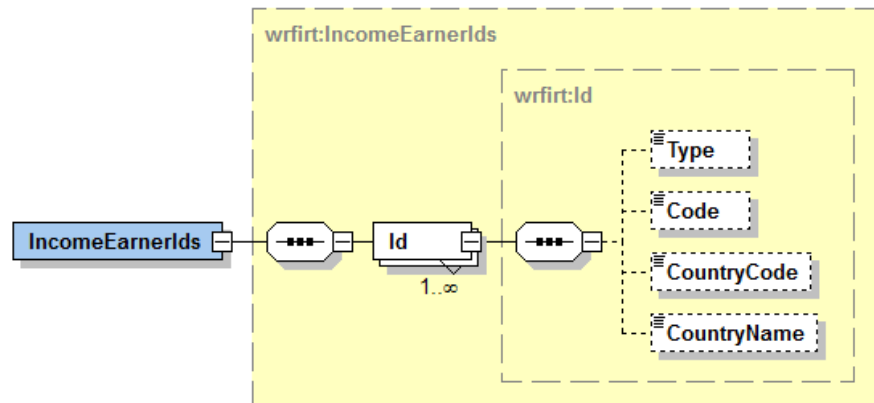

Data group details:

Data designation	Type	Allowed values	V/ M	Processing rule
Income earner identifiers (IncomeEarnerIds)	wrfirt:IncomeEarnerIds		V	Data groups or data items belonging to this data group and marked as voluntary are returned if they were submitted in the report, and are included in the data access profile used to query the record.
Income earner identifier (Id)	wrfirt:Id		M	An income earner can have several identifiers.
Identifier type (Type)	xs:int	Codes: IdType	V	
Identifier (Code)	irct:String30		V	
Country code (CountryCode)	irct:String2	A two-character code in accordance with the ISO 3166 country codes. If the country is unknown, the value is "99".	V	



Data designation	Type	Allowed values	V/ M	Processing rule
Country name (CountryName)	irct:String70		V	

2.20 Basic income earner details (IncomeEarnerBasic)

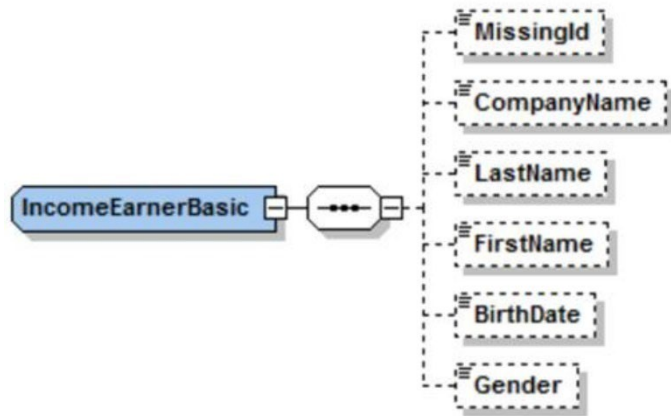

Data group details:

Data designation	Type	Allowed values	V/ M	Processing rule
Basic income earner details (IncomeEarnerBasic)	wrfirt:IncomeEarnerBasic		V	Data groups or data items belonging to this data group and marked as voluntary are returned if they were submitted in the report, and are included in the data access profile used to query the record.
The income earner does not have a customer ID (MissingId)	irct:true	"true"	V	
Company name (CompanyName)	irct:String200		V	
Last name (LastName)	irct:String200		V	

Data designation	Type	Allowed values	V/ M	Processing rule
First name (FirstName)	irct:String100		V	
Date of birth (BirthDate)	xs:date		V	
Gender (Gender)	xs:int	Codes: Gender	V	

2.21 Income earner's addresses (Addresses)

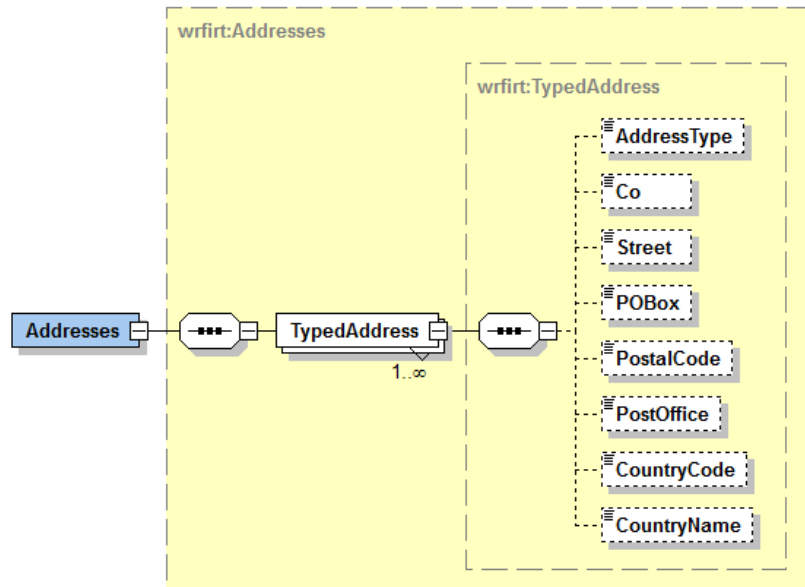

Data group details:

Data designation	Type	Allowed values	V/ M	Processing rule
Income earner's addresses (Addresses)	wrfirt:Addresses		V	Data groups or data items belonging to this data group and marked as voluntary are returned if they were submitted in the report, and are included in the data access profile used to query the record. Address information under an access restriction to personal data will not be shared.
Income earner's address (TypedAddress)	wrfirt:TypedAddresses		M	An income earner can have several addresses.
Address type (AddressType)	xs:int	Codes: AddressType	V	
c/o (Co)	irct:String70		V	
Street address (Street)	irct:String100		V	
P.O. Box (POBox)	irct:String10		V	
Postal code (PostalCode)	irct:String20		V	
City (PostOffice)	irct:String200		V	
Country code (CountryCode)	irct:String2	A two-character code in accordance with the ISO 3166 country codes. If the country is unknown, the value is "99".	V	
Country name (CountryName)	irct:String70		V	



2.22 Income earner's suborganisations (SubOrgs)

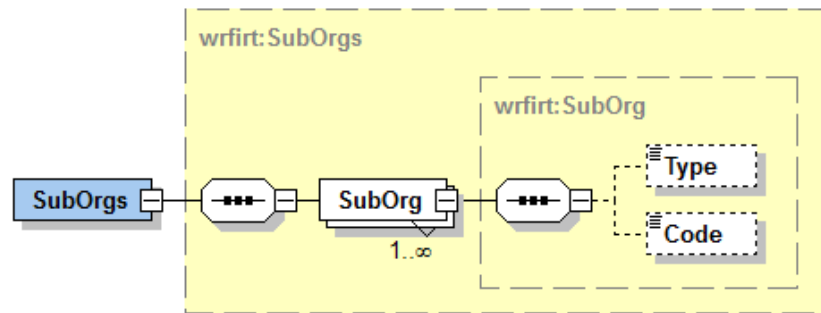

Data group details:

Data designation	Type	Allowed values	V/ M	Processing rule
Income earner's suborganisations (SubOrgs)	wrfirt:SubOrgs		V	Data groups or data items belonging to this data group and marked as voluntary are returned if they were submitted in the report, and are included in the data access profile used to query the record.
Income earner's suborganisation (SubOrg)	wrfirt:SubOrg		M	An income earner can have several suborganisations.
Suborganisation's identifier type (Type)	xs:int	Codes: IncomeEarnerSubOrgType	V	
Suborganisation identifier (Code)	irct:String20		V	



2.23 Employment relationship data (Employment)

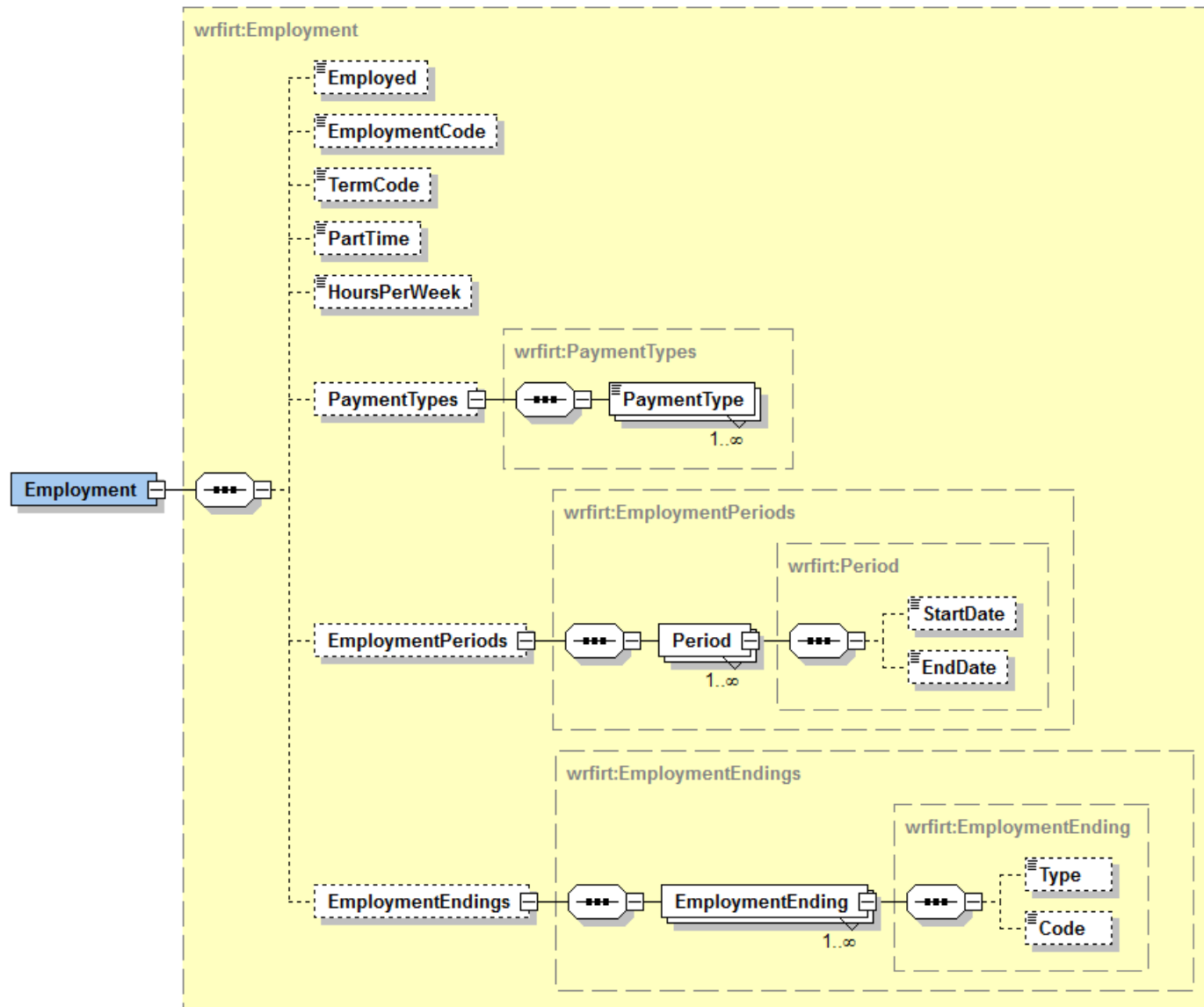

Data group details:

Data designation	Type	Allowed values	V/ M	Processing rule
Employment relationship data (Employment)	wrfirt:Employment		V	Data groups or data items belonging to this data group and marked as voluntary are returned if they were submitted in the report, and are included in the data access profile used to query the record.
Employed (Employed)	irct:trueOrFalse		V	
Employment type (EmploymentCode)	xs:int	Codes: EmploymentCode	V	
Duration of employment (TermCode)	xs:int	Codes: TermCode	V	
Part-time % (PartTime)	irct:decimal2		V	
Regular agreed working hours per week (HoursPerWeek)	irct:decimal2		V	
Forms of payment (PaymentTypes)	wrfirt:PaymentTypes		V	
Form of payment (PaymentType)	xs:int	Codes: PaymentType	M	An income earner can have several forms of payment.
Employment period (EmploymentPeriods)	wrfirt:EmploymentPeriods		V	
Time of employment (Period)	wrfirt:Period		M	An income earner can have several times of employment.
Start date (StartDate)	xs:date		V	
End date (EndDate)	xs:date		V	
Termination of employment (EmploymentEndings)	wrfirt:EmploymentEndings		V	
Reason for the termination of employment (EmploymentEnding)	wrfirt:EmploymentEnding		M	An income earner can have several reasons for the termination of employment.
Reason codes for termination of employment (Type)	xs:int	Codes: EmploymentEndingType	V	



Data designation	Type	Allowed values	V/ M	Processing rule
Reason code for termination of employment (Code)	irct:String20		V	

2.24 Occupation (Professions)

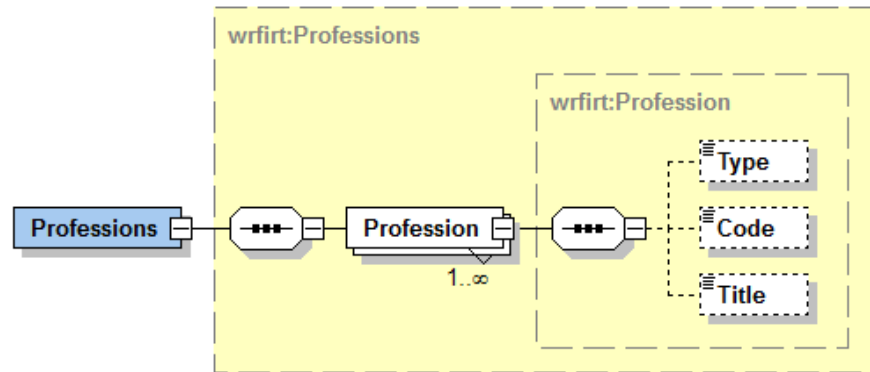

Data group details:

Data designation	Type	Allowed values	V/ M	Processing rule
Occupation (Professions)	wrfirt:Professions		V	Data groups or data items belonging to this data group and marked as voluntary are returned if they were submitted in the report, and are included in the data access profile used to query the record.
Occupational class or title (Profession)	wrfirt:Profession		M	An income earner can have several "Occupational class or title" entries.
Type of occupational title or classification (Type)	xs:int	Codes: ProfessionType	V	
Occupational class or title identifier (Code)	irct:String20		V	
Title (free text) (Title)	irct:String200		V	



2.25 Employment registration (EmploymentRegs)

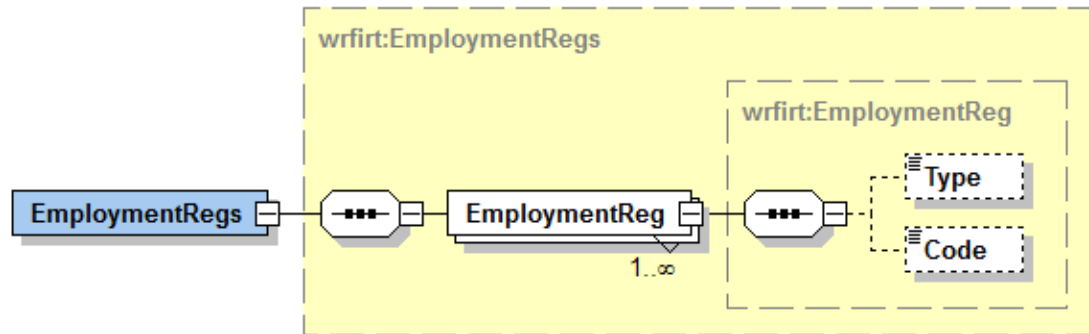

Data group details:

Data designation	Type	Allowed values	V/ M	Processing rule
Employment registration (EmploymentRegs)	wrfirt:Employment Regs		V	Data groups or data items belonging to this data group and marked as voluntary are returned if they were submitted in the report, and are included in the data access profile used to query the record.
Grounds for registration (EmploymentReg)	wrfirt:Employment Reg		M	An income earner can have several grounds for registration.
Type of registration grounds (Type)	xs:int	Codes: EmploymentRegType	V	
Registration grounds identifier (Code)	irct:String20		V	



2.26 Place of business (PlaceOfBusiness)

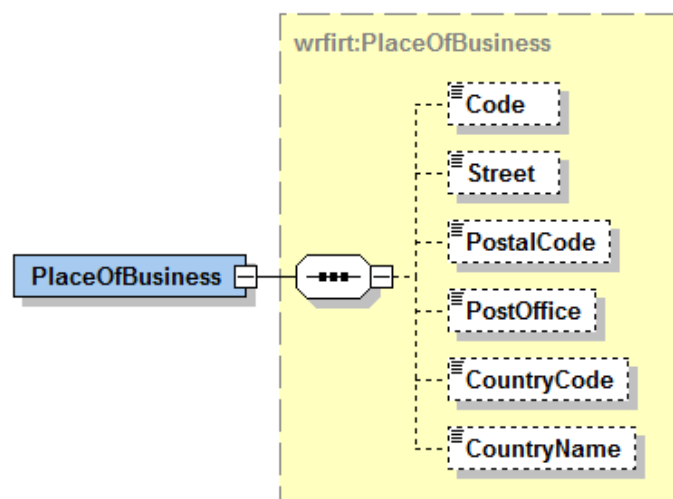

Data group details:

Data designation	Type	Allowed values	V/ M	Processing rule
Income earner's place of business (PlaceOfBusiness)	wrfirt:PlaceOfBusiness		V	Data groups or data items belonging to this data group and marked as voluntary are returned if they were submitted in the report, and are included in the data access profile used to query the record.
Place of business code (Code)	irct:String20		V	
Street address (Street)	irct:String100		V	
Postal code (PostalCode)	irct:String20		V	
City (PostOffice)	irct:String200		V	
Country code (CountryCode)	irct:String2	A two-character code in accordance with the ISO 3166 country codes.	V	

Data designation	Type	Allowed values	V/ M	Processing rule
		If the country is unknown, the value is "99".		
Country name (CountryName)	irct:String70		V	

2.27 Earnings-related pension insurance (PensionInsurance)

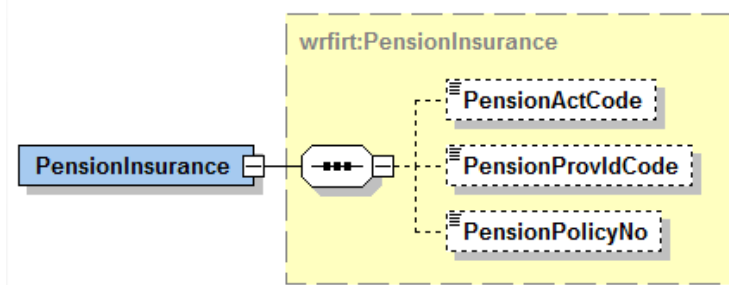

Data group details:

Data designation	Type	Allowed values	V/ M	Processing rule
Earnings-related pension insurance (PensionInsurance)	wrfirt:PensionInsurance		V	Data groups or data items belonging to this data group and marked as voluntary are returned if they were submitted in the report, and are included in the data access profile used to query the record.
Earnings-related pension insurance information (PensionActCode)	xs:int	Codes: PensionActCode	V	
Pension provider code (PensionProvdCode)	xs:int	Codes: PensionProvdCode	V	
Pension policy number (PensionPolicyNo)	irct:PensionPolicyNo	Pension policy number codes of	V	

Data designation	Type	Allowed values	V/ M	Processing rule
		earnings-related pension providers		

2.28 Occupational accident insurance (AccidentInsurance)

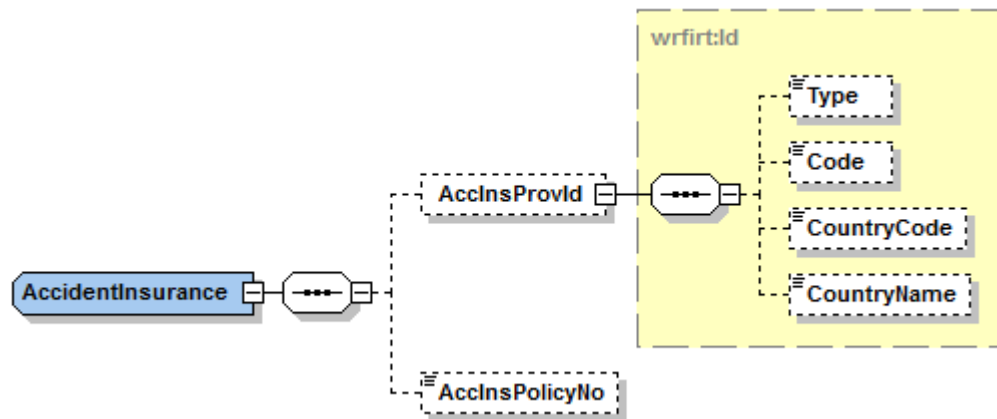

Data group details:

Data designation	Type	Allowed values	V/ M	Processing rule
Occupational accident insurance (AccidentInsurance)	wrfirt:AccidentInsurance		V	Data groups or data items belonging to this data group and marked as voluntary are returned if they were submitted in the report, and are included in the data access profile used to query the record.
Occupational accident insurance company identifier (AcclnsProvId)	wrfirt:Id		V	
Identifier type (Type)	xs:int	Codes: IdType	V	
Identifier (Code)	irct:String30		V	
Country code (CountryCode)	irct:String2	A two-character code in accordance with the ISO 3166 country codes. If the country is unknown, the	V	



Data designation	Type	Allowed values	V/ M	Processing rule
		value "99" is entered.		
Country name (CountryName)	irct:String70		V	
Occupational accident insurance policy number (AcclnsPolicyNo)	irct:String20		V	



2.29 Insurance exceptions (InsuranceExceptions)

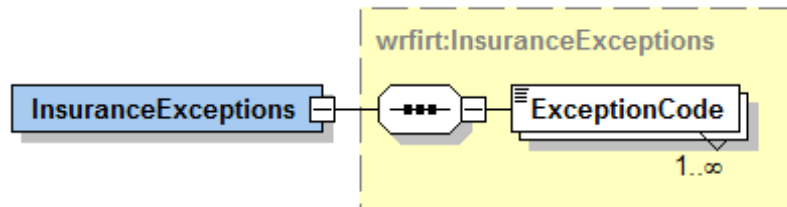

Data group details:

Data designation	Type	Allowed values	V/ M	Processing rule
Insurance exceptions (InsuranceExceptions)	wrfirt:InsuranceExc ptions		V	Data groups or data items belonging to this data group and marked as voluntary are returned if they were submitted in the report, and are included in the data access profile used to query the record.
Type of exception to insurance (ExceptionCode)	xs:int	Codes: InsuranceExceptionC ode	M	There may be several types of exception to insurance.



2.30 International situations (InternationalData)

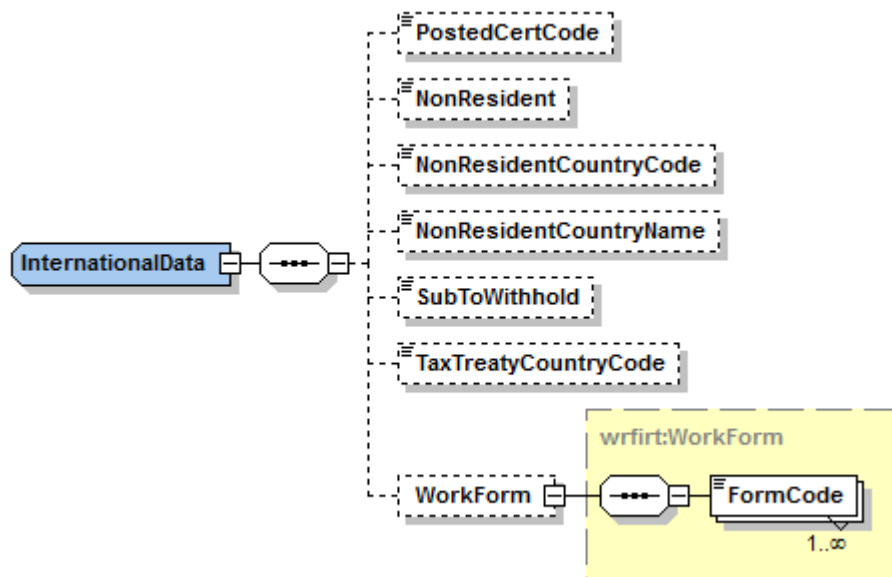

Data group details:

Data designation	Type	Allowed values	V/ M	Processing rule
International situations (InternationalData)	wrfirt:InternationalData		V	Data groups or data items belonging to this data group and marked as voluntary are returned if they were submitted in the report, and are included in the data access profile used to query the record.
Social security certificate (PostedCertCode)	xs:int	Codes: PostedCertCode	V	
Non-resident taxpayer (NonResident)	irct:true	"true"	V	
Country code of country of residence (NonResidentCountryCode)	irct:String2	A two-character code in accordance with the ISO 3166 country codes.	V	



Data designation	Type	Allowed values	V/ M	Processing rule
		If the country is unknown, the value is "99".		
Name of country of residence (NonResidentCountryName)	irct:String70		V	
Income subject to withholding (SubToWithhold)	irct:true	"true"	V	
Tax-treaty country code (TaxTreatyCountryCode)	irct:String2	Codes: TaxTreatyCountryCode	V	
Forms for work abroad (WorkForm)	wrfirt:WorkForm		V	
Form type (FormCode)	xs:int	Codes: FormCode	M	There may be several form types.

2.31 Other details (IncomeEarnerOther)

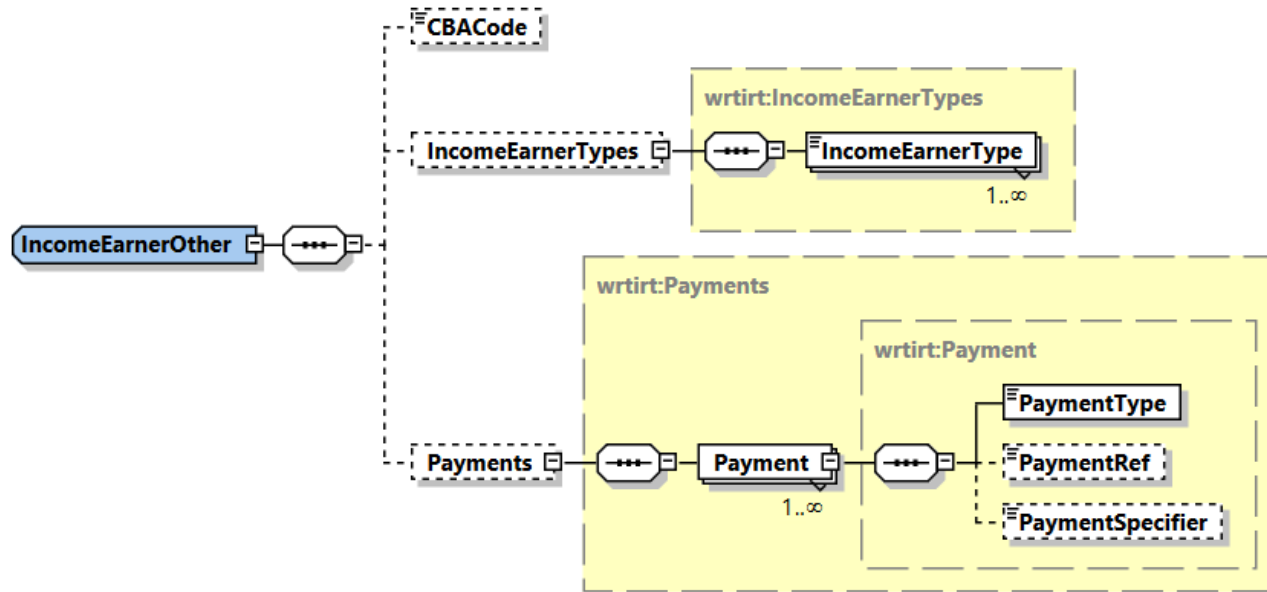

Data group details:

Data designation	Type	Allowed values	V/ M	Processing rule
Other details (IncomeEarnerOther)	wrfirt:IncomeEarnerOther		V	Data groups or data items belonging to this data group and marked as voluntary are returned if they were submitted in the report, and are included in the data access profile used to query the record.
Applicable collective agreement (CBACode)	xs:int	Codes: CBACode	V	
Additional income earner details	wrfirt:IncomeEarnerTypes		V	

Data designation	Type	Allowed values	V/ M	Processing rule
Type of additional income earner data (IncomeEarnerType)	xs:int	Codes: IncomeEarnerType	M	There may be several types of additional income earner data.
Details of payments (Payments)	wrfirt:Payments		V	There can be several payment data entries.
Payment details (Payment)	wrfirt:Payment		M	
Payment data type (PaymentType)	xs:int	code set RefPaymentType	V	
Payment's reference number(PaymentRef)	irct:String50		V	
Payment specifier (PaymentSpecifier)	irct:String200		V	

2.32 Income types (Transactions)

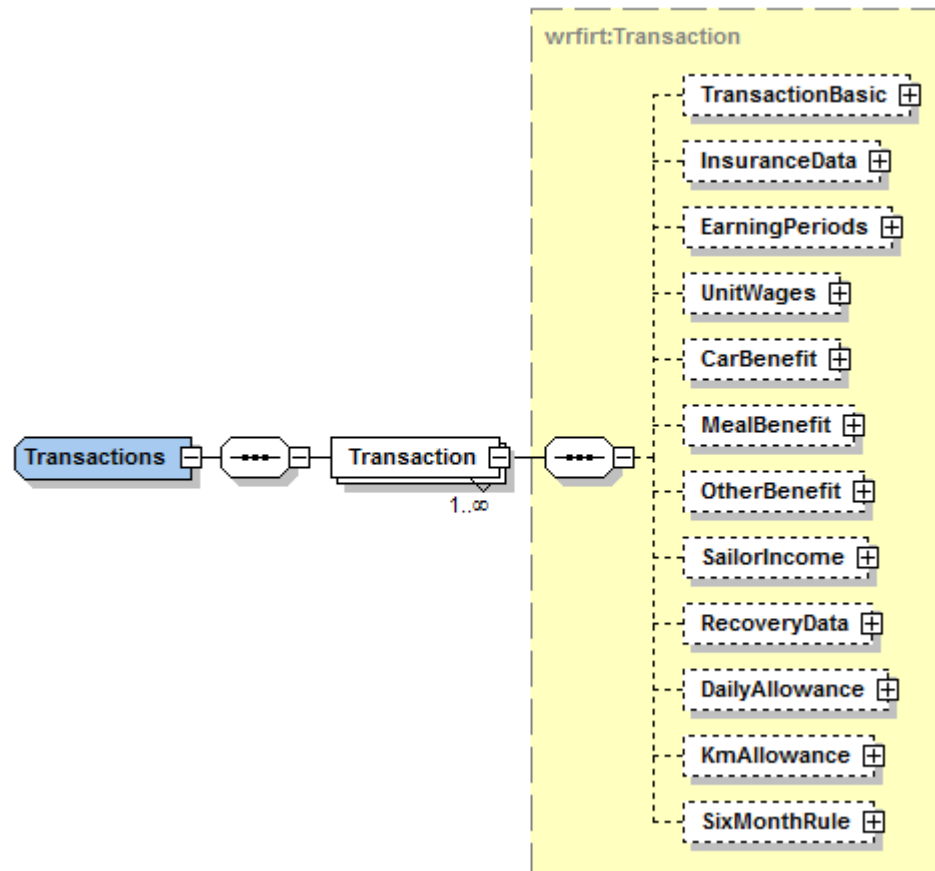

Data group details:

Data designation	Type	Allowed values	V/ M	Processing rule
Income types (Transactions)	wrfirt:Transactions		V	Data groups or data items belonging to this data group and marked as voluntary are returned if they were submitted in the

Data designation	Type	Allowed values	V/ M	Processing rule
				report, and are included in the data access profile used to query the record.
Income type details (Transactions)	wrfirt:Transaction		M	There may be several income types.
General details on the income type (TransactionBasic)	wrfirt:TransactionBasic		V	
Insurance information (InsuranceData)	wrfirt:InsuranceData		V	
Earnings periods (EarningPeriods)	wrfirt:EarningPeriods		V	
Unit of the wages (UnitWages)	wrfirt:UnitWages		V	
Car benefit (CarBenefit)	wrfirt:CarBenefit		V	
Meal benefit (MealBenefit)	wrfirt:MealBenefit		V	
Other fringe benefit (Otherbenefit)	wrfirt:OtherBenefit		V	
Seafarer's income (SailorIncome)	wrfirt:SailorIncome		V	
Additional details on recovery (RecoveryData)	wrfirt:RecoveryData		V	
Daily allowance (DailyAllowance)	wrfirt:DailyAllowance		V	
Kilometre allowance (tax-exempt) (KmAllowance)	wrfirt:KmAllowance		V	
Six-month rule (SixMonthRule)	wrfirt:SixMonthRule		V	

2.33 General details on the income type (TransactionBasic)

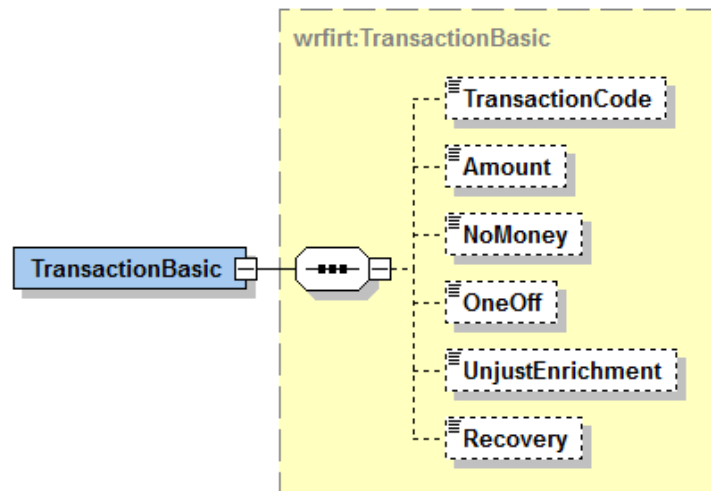

Data group details:

Data designation	Type	Allowed values	V/ M	Processing rule
General details on the income type (TransactionBasic)	wrfirt:TransactionBasic		V	Data groups or data items belonging to this data group and marked as voluntary are returned if they were submitted in the report, and are included in the data access profile used to query the record.
Income type code (TransactionCode)	xs:int	Codes: TransactionCode	V	
Amount (Amount)	irct:decimal2		V	
Payment other than money (NoMoney)	irct:true	"true"	V	
One-off remuneration (OneOff)	irct:true	"true"	V	
Unjust enrichment (UnjustEnrichment)	irct:true	"true"	V	



Data designation	Type	Allowed values	V/ M	Processing rule
Recovery (Recovery)	irct:true	"true"	V	

2.34 Insurance information (InsuranceData)

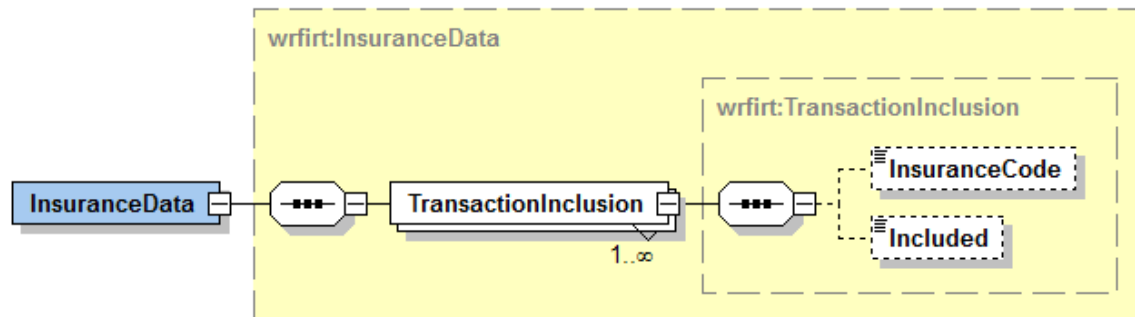

Data group details:

Data designation	Type	Allowed values	V/ M	Processing rule
Insurance information (InsuranceData)	wrfirt:InsuranceData		V	Data groups or data items belonging to this data group and marked as voluntary are returned if they were submitted in the report, and are included in the data access profile used to query the record.
Insurance information (TransactionInclusion)	wrfirt:TransactionInclusion		M	There may be several insurance information entries.
Insurance information type (InsuranceCode)	xs:int	Codes: InsuranceCode	V	
Grounds for insurance contribution (Included)	irct:trueOrFalse		V	



2.35 Earnings periods (EarningPeriods)

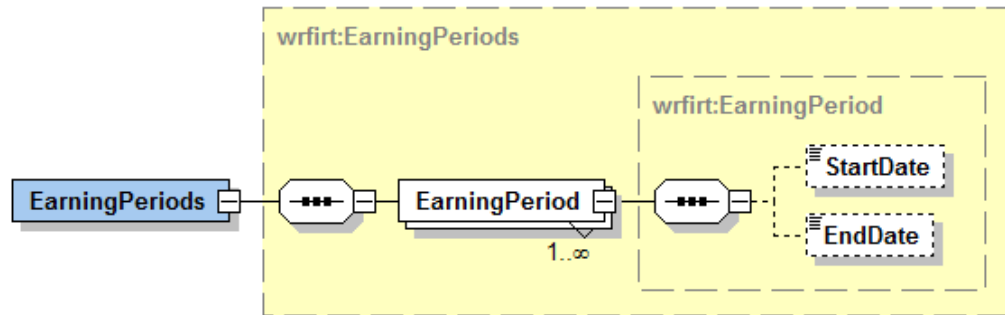

Data group details:

Data designation	Type	Allowed values	V/ M	Processing rule
Earnings periods (EarningPeriods)	wrfirt:EarningPeriods		V	Data groups or data items belonging to this data group and marked as voluntary are returned if they were submitted in the report, and are included in the data access profile used to query the record.
Earnings period (EarningPeriod)	wrfirt:EarningPeriod		M	There may be several earnings periods.
Start date (StartDate)	xs:date		V	
End date (EndDate)	xs:date		V	



2.36 Unit of the wages (UnitWages)

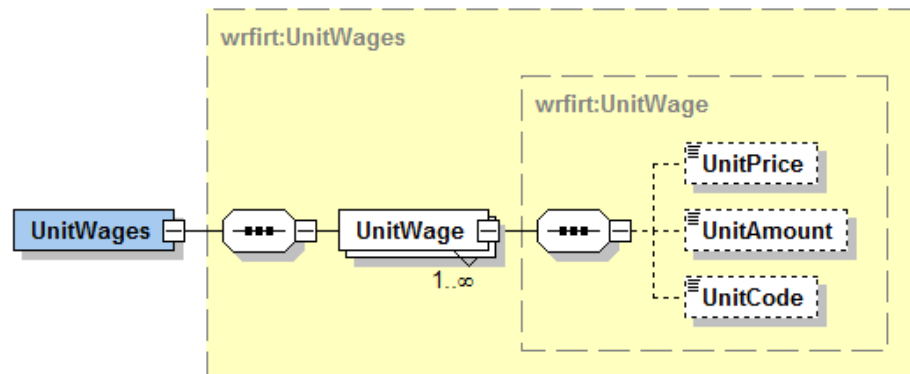

Data group details:

Data designation	Type	Allowed values	V/ M	Processing rule
Unit of the wages (UnitWages)	wrfirt:UnitWages		V	Data groups or data items belonging to this data group and marked as voluntary are returned if they were submitted in the report, and are included in the data access profile used to query the record.
Unit wage (UnitWage)	wrfirt:UnitWage		M	There may be several unit wages.
Unit price (UnitPrice)	irct:decimal2		V	
Number of units (UnitAmount)	irct:decimal2		V	
Unit (UnitCode)	xs:int	Codes: WageUnitCode	V	



2.37 Car benefit (CarBenefit)

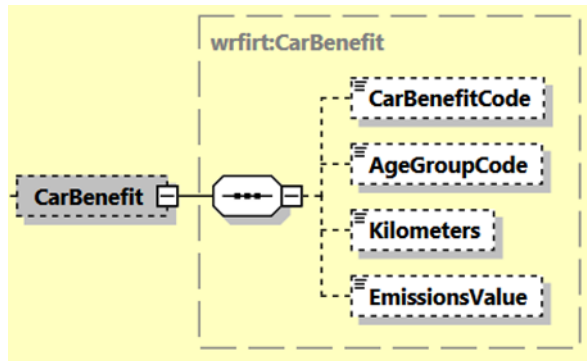

Data group details:

Data designation	Type	Allowed values	V/ M	Processing rule
Car benefit (CarBenefit)	wrfirt:CarBenefit		V	Data groups or data items belonging to this data group and marked as voluntary are returned if they were submitted in the report, and are included in the data access profile used to query the record.
Car benefit type (CarBenefitCode)	xs:int	Codes: CarBenefitCode	V	
Car age group (AgeGroupCode)	xs:int	Codes: AgeGroupCode	V	
Odometer reading (Kilometers)	xs:int		V	
Car emissions value (EmissionsValue)	irct:decimal2		V	



2.38 Meal benefit (MealBenefit)

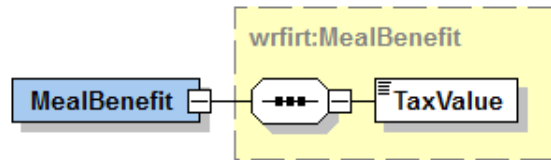

Data group details:

Data designation	Type	Allowed values	V/ M	Processing rule
Meal benefit (MealBenefit)	wrfirt:MealBenefit		V	Data groups or data items belonging to this data group and marked as voluntary are returned if they were submitted in the report, and are included in the data access profile used to query the record.
Reimbursement for a meal benefit corresponds to taxable value (TaxValue)	irct:true	"true"	M	



2.39 Other fringe benefit (Otherbenefit)

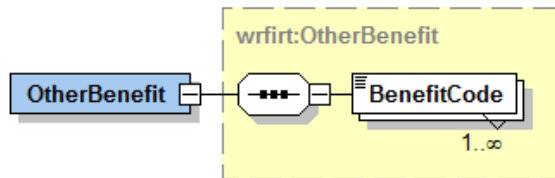

Data group details:

Data designation	Type	Allowed values	V/ M	Processing rule
Other fringe benefit (Otherbenefit)	wrfirt:OtherBenefit		V	Data groups or data items belonging to this data group and marked as voluntary are returned if they were submitted in the report, and are included in the data access profile used to query the record.
Benefit type (BenefitCode)	xs:int	Codes: BenefitCode	M	There may be several benefit types.



2.40 Seafarer's income (SailorIncome)

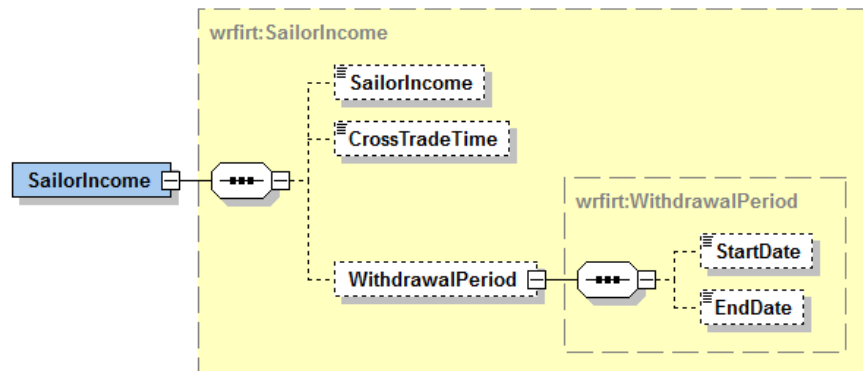

Data group details:

Data designation	Type	Allowed values	V/ M	Processing rule
Seafarer's income (SailorIncome)	wrfirt:SailorIncome		V	Data groups or data items belonging to this data group and marked as voluntary are returned if they were submitted in the report, and are included in the data access profile used to query the record.
Payment is seafarer's income (SailorIncome)	irct:true	"true"	V	
Time of cross trade (CrossTradeTime)	xs:int		V	
Withdrawal period (WithdrawalPeriod)	wrfirt:WithdrawalPeriod		V	
Start date (StartDate)	xs:date		V	
End date (EndDate)	xs:date		V	



2.41 Additional details on recovery (RecoveryData)

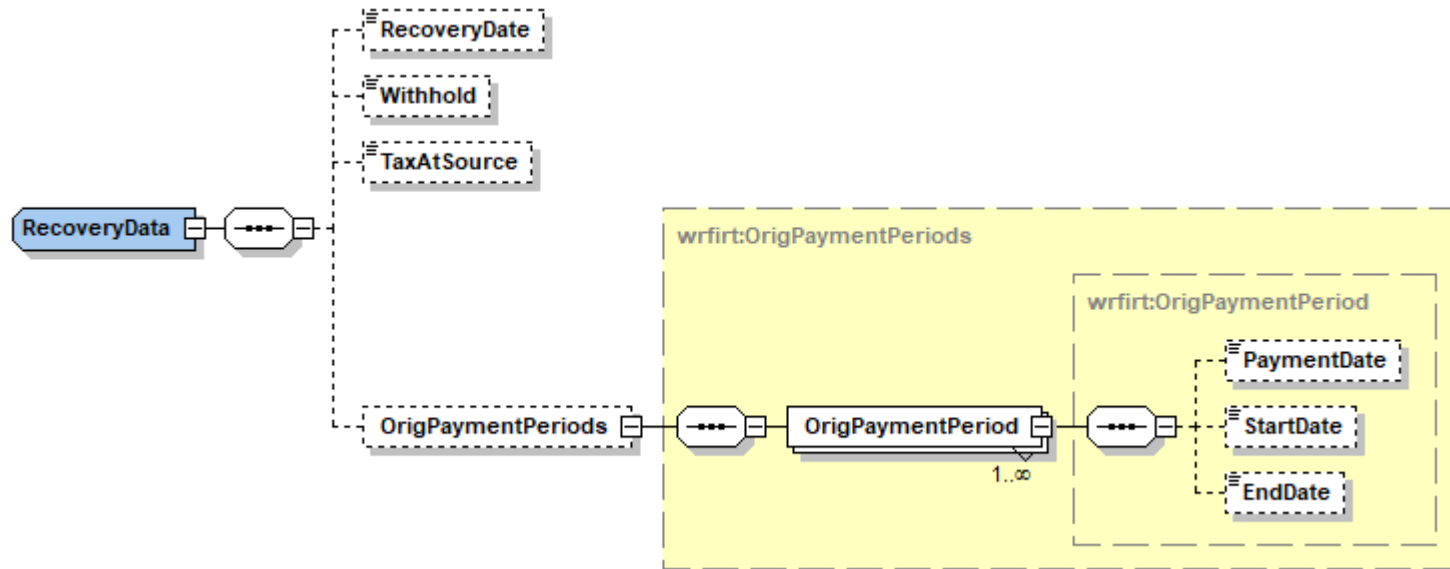

Data group details:

Data designation	Type	Allowed values	V/ M	Processing rule
Additional details on recovery (RecoveryData)	wrfirt:RecoveryData		V	Data groups or data items belonging to this data group and marked as voluntary are returned if they were submitted in the report, and are included in the data access profile used to query the record.
Recovery date (RecoveryDate)	xs:date		V	
Withholding from the recovered amount (Withhold)	irct:decimal2		V	
Tax at source from the recovered amount (TaxAtSource)	irct:decimal2		V	
Original payment periods (OrigPaymentPeriods)	wrfirt:OrigPaymentPeriods		V	

Data designation	Type	Allowed values	V/ M	Processing rule
Original payment period (OrigPaymentPeriod)	wrfirt:OrigPayment Period		M	There may be several original payment periods.
Payment date (PaymentDate)	xs:date		V	
Start date (StartDate)	xs:date		V	
End date (EndDate)	xs:date		V	

2.42 Daily allowance (DailyAllowance)

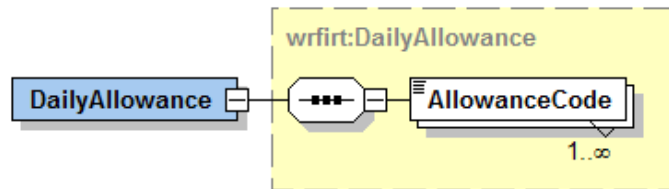

Data group details:

Data designation	Type	Allowed values	V/ M	Processing rule
Daily allowance (DailyAllowance)	wrfirt:DailyAllowance		V	Data groups or data items belonging to this data group and marked as voluntary are returned if they were submitted in the report, and are included in the data access profile used to query the record.
Daily allowance type (AllowanceCode)	xs:int	Codes: AllowanceCode	M	There may be several daily allowance types.

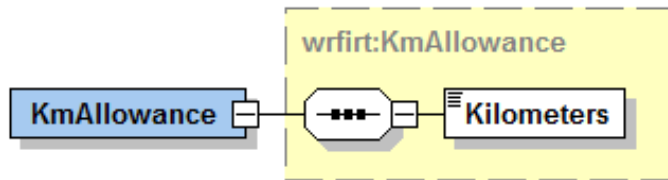

2.43 Kilometre allowance (tax-exempt) (KmAllowance)**Data group details:**

Data designation	Type	Allowed values	V/ M	Processing rule
Kilometre allowance (tax-exempt) (KmAllowance)	wrfirt:KmAllowance		V	Data groups or data items belonging to this data group and marked as voluntary are returned if they were submitted in the report, and are included in the data access profile used to query the record.
Number of kilometres (Kilometers)	xs:int		M	



2.44 Six-month rule (SixMonthRule)

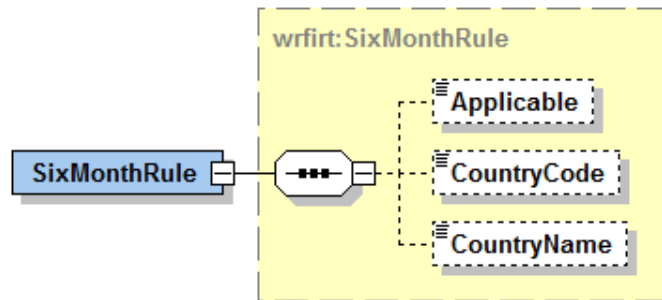

Data group details:

Data designation	Type	Allowed values	V/ M	Processing rule
Six-month rule (SixMonthRule)	wrfirt:SixMonthRule		V	Data groups or data items belonging to this data group and marked as voluntary are returned if they were submitted in the report, and are included in the data access profile used to query the record.
Six-month rule is applicable (Applicable)	irct:trueOrFalse		V	
Country code (CountryCode)	irct:String2	A two-character code in accordance with the ISO 3166 country codes. If the country is unknown, the value is "99".	V	
Country name (CountryName)	irct:String70		V	



2.45 Details on foreign leased workforce (ForeignLeasedWork)

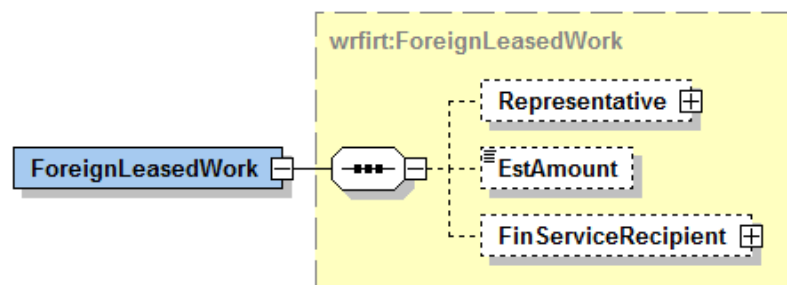

Data group details:

Data designation	Type	Allowed values	V/ M	Processing rule
Details on foreign leased workforce (ForeignLeasedWork)	wrfirt:ForeignLeasedWork		V	Data groups or data items belonging to this data group and marked as voluntary are returned if they were submitted in the report, and are included in the data access profile used to query the record.
Representative (Representative)	wrfirt:Representative		V	
Estimated pay amount (EstAmount)	irct:decimal2		V	
Finnish employer (FinServiceRecipient)	wrfirt:FinServiceRecipient		V	

2.46 Representative (Representative)

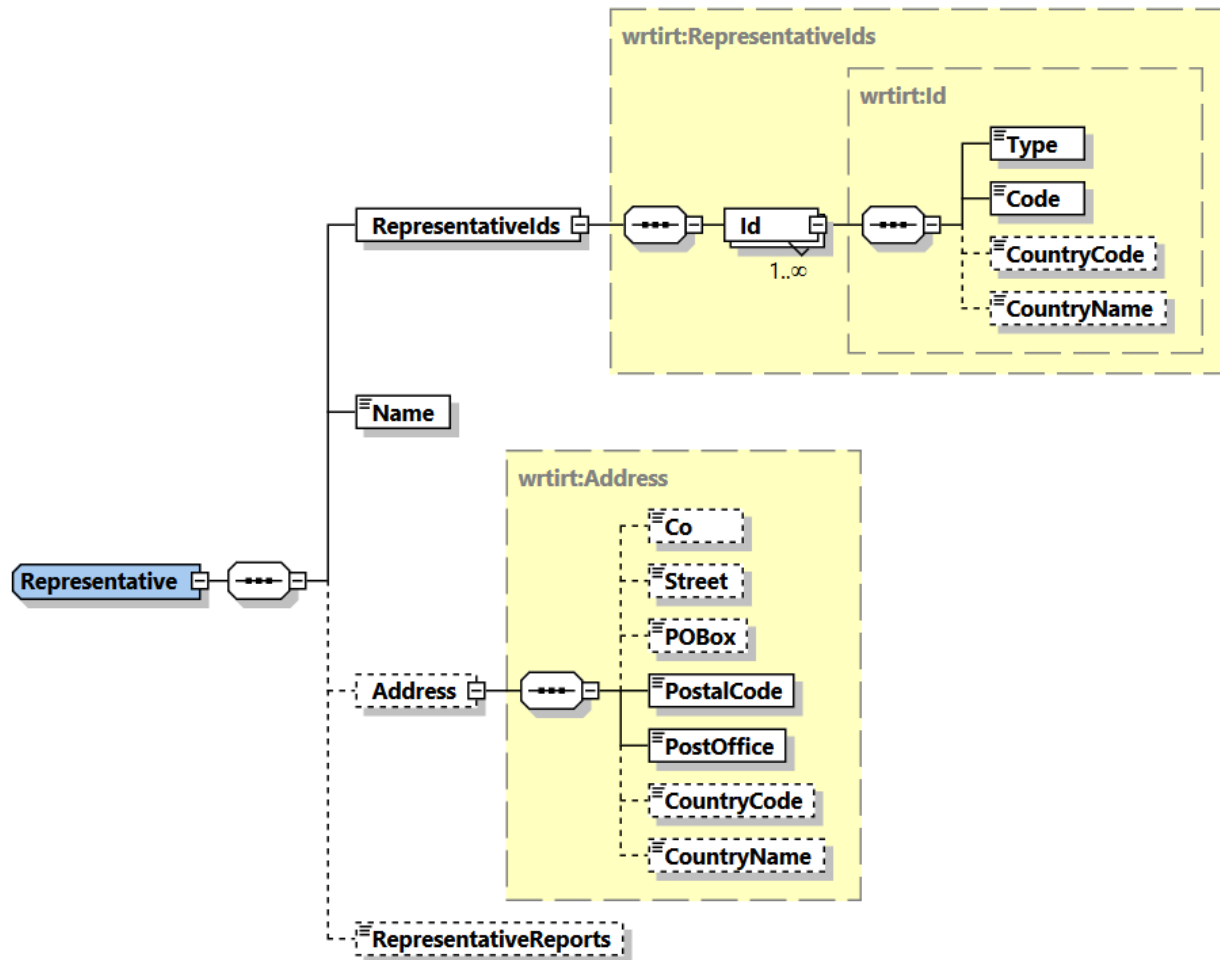

Data group details:

Data designation	Type	Allowed values	V/ M	Processing rule
Representative (Representative)	wrfirt:Representative		V	Data groups or data items belonging to this data group and marked as voluntary are returned if they were submitted in the report, and are included in the data access profile used to query the record.
Representative identifiers (RepresentativeIds)	wrfirt:RepresentativeIds		V	
Representative identifier (Id)	wrfirt:Id		M	There may be several representative identifiers.
Identifier type (Type)	xs:int	Codes: IdType	V	
Identifier (Code)	irct:String30		V	
Country code (CountryCode)	irct:String2	A two-character code in accordance with the ISO 3166 country codes. If the country is unknown, the value is "99".	V	
Country name (CountryName)	irct:String70		V	
Representative's name (Name)	irct:String200		V	
Representative's address (Address)	wrfirt:Address		V	Address information under an access restriction to personal data will not be shared.
c/o (Co)	irct:String70		V	
Street address (Street)	irct:String100		V	
P.O. Box (POBox)	irct:String10		V	
Postal code (PostalCode)	irct:String20		V	
City (PostOffice)	irct:String200		V	
Country code (CountryCode)	irct:String2	A two-character code in accordance	V	



Data designation	Type	Allowed values	V/ M	Processing rule
		with the ISO 3166 country codes. If the country is unknown, the value is "99".		
Country name (CountryName)	irct:String70		V	
Representative acts as submitter (RepresentativeReports)	irct:true	"true"	V	



2.47 Finnish employer (FinServiceRecipient)

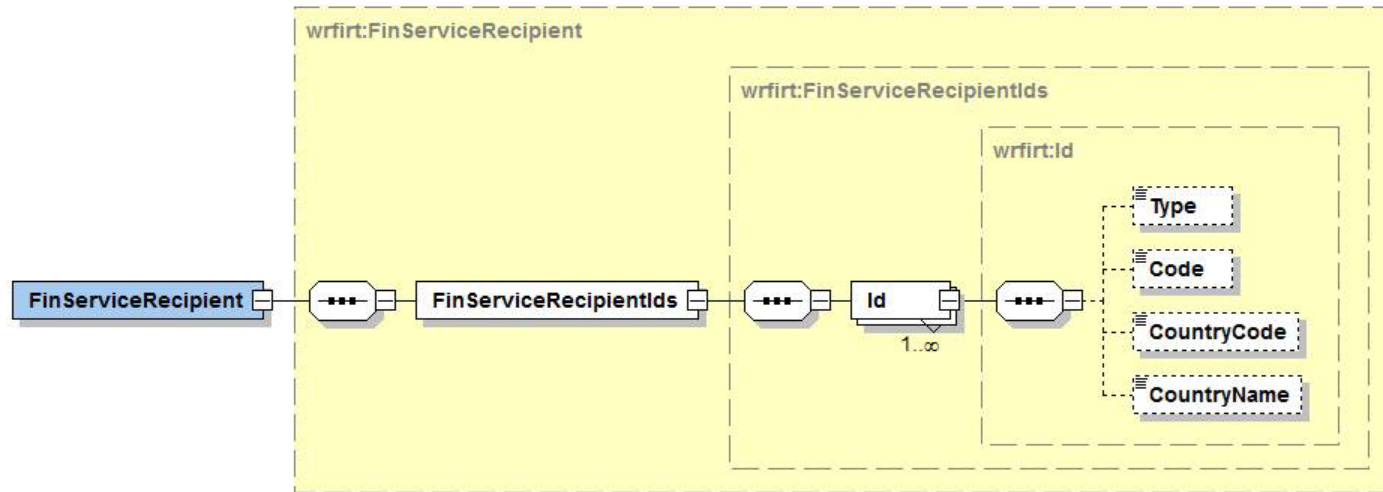

Data group details:

Data designation	Type	Allowed values	V/ M	Processing rule
Finnish employer (FinServiceRecipient)	wrfirt:FinServiceRecipient		V	Data groups or data items belonging to this data group and marked as voluntary are returned if they were submitted in the report, and are included in the data access profile used to query the record.
Employer identifiers (FinServiceRecipientIds)	wrfirt:FinServiceRecipientIds		M	
Employer identifier (Id)	wrfirt:Id		M	There may be several employer identifiers.
Identifier type (Type)	xs:int	Codes: IdType	V	
Identifier (Code)	irct:String30		V	
Country code (CountryCode)	irct:String2	A two-character code in accordance	V	



Data designation	Type	Allowed values	V/ M	Processing rule
		with the ISO 3166 country codes. If the country is unknown, the value is "99".		
Country name (CountryName)	irct:String70		V	



2.48 Stay periods in Finland (StayPeriodInFinland)

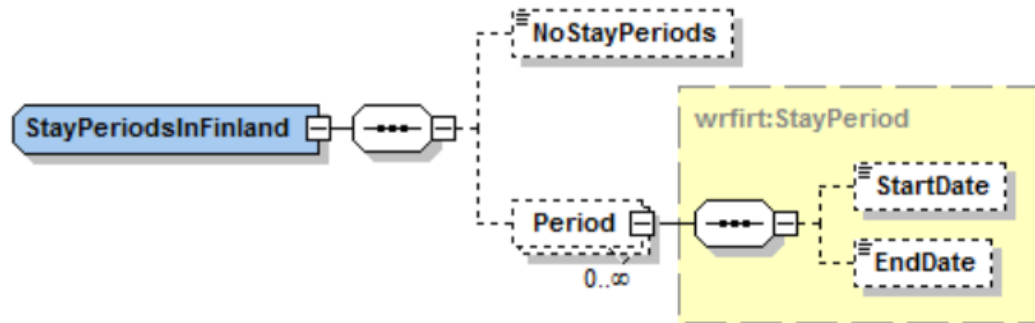

Data group details:

Data designation	Type	Allowed values	V/ M	Processing rule
Stay periods in Finland (StayPeriodInFinland)	wrfirt:StayPeriodsInFinland		V	Data groups or data items belonging to this data group and marked as voluntary are returned if they were submitted in the report, and are included in the data access profile used to query the record.
Report contains no stay periods in Finland (NoStayPeriods)	irct:true	"true"	V	
Stay period in Finland (StayPeriodInFinland)	wrfirt:StayPeriod		V	There may be several stay periods in Finland.
Start date (StartDate)	xs:date		V	
End date (EndDate)	xs:date		V	



2.49 Work periods in Finland (WorkPeriodsInFinland)

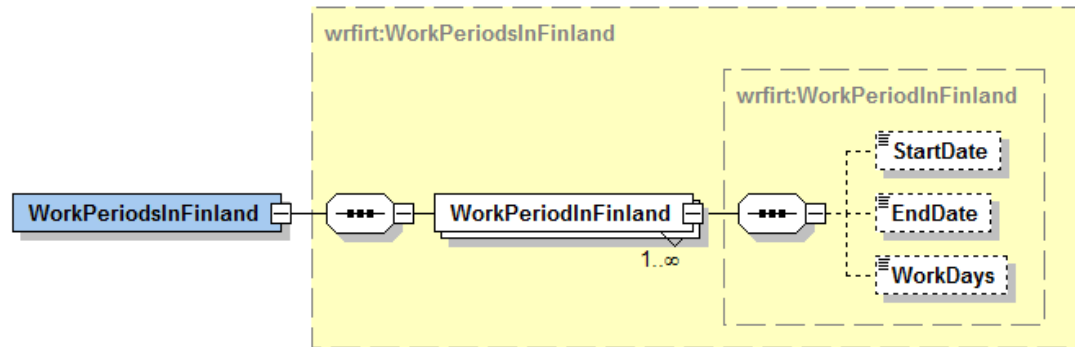

Data group details:

Data designation	Type	Allowed values	V/ M	Processing rule
Work periods in Finland (WorkPeriodsInFinland)	wrfirt:WorkPeriodsInFinland		V	Data groups or data items belonging to this data group and marked as voluntary are returned if they were submitted in the report, and are included in the data access profile used to query the record.
Work period in Finland (WorkPeriodInFinland)	wrfirt:WorkPeriodInFinland		M	There may be several work periods in Finland.
Start date (StartDate)	xs:date		V	
End date (EndDate)	xs:date		V	
Number of workdays in Finland (WorkDays)	xs:int		V	

2.50 Countries of work (WorkCountries)

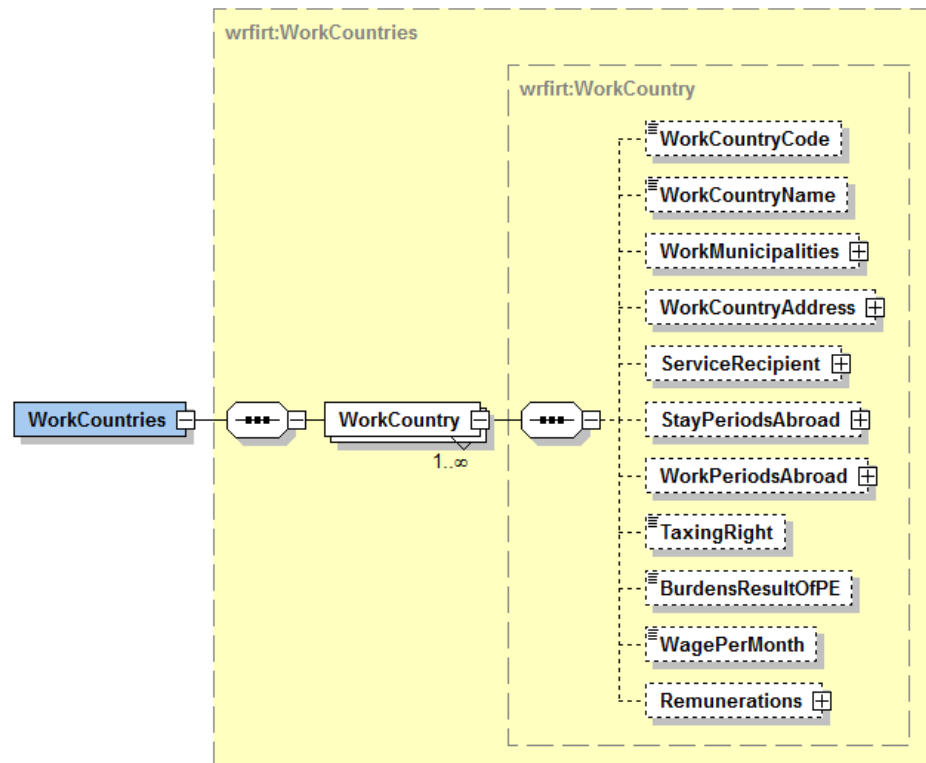

Data group details:

Data designation	Type	Allowed values	V/ M	Processing rule
Countries of work (WorkCountries)	wrfirt:WorkCountries		V	Data groups or data items belonging to this data group and marked as voluntary are returned if they were submitted in the report, and are included in the data access profile used to query the record.
Country of work (WorkCountries)	wrfirt:WorkCountry		M	There may be several countries of work.

Data designation	Type	Allowed values	V/ M	Processing rule
Code of country of work (WorkCountryCode)	irct:String2	A two-character code in accordance with the ISO 3166 country codes. If the country is unknown, the value is "99".	V	
Name of country of work (WorkCountryName)	irct:String70		V	
Districts of work (WorkMunicipalities)	wrfirt:WorkMunicipalities		V	
Address in country of work (WorkCountryAddress)	wrfirt:WorkCountryAddress		V	
Principal (ServiceRecipient)	wrfirt:ServiceRecipient		V	
Stay periods in country of work (StayPeriodsAbroad)	wrfirt:StayPeriodsAbroad		V	
Work periods abroad (WorkPeriodsAbroad)	wrfirt:WorkPeriodsAbroad		V	
Country of work has taxing right (TaxingRight)	irct:trueOrFalse		V	
Pay burdens the result of the employer's permanent establishment in the country of work (BurdensResultOfPE)	irct:trueOrFalse		V	
Pay per month (WagePerMonth)	irct:decimal2		V	
Other remunerations and benefits (Remunerations)	wrfirt:Remunerations		V	

2.51 Districts of work (WorkMunicipalities)

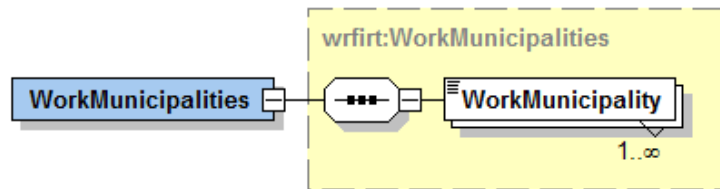

Data group details:

Data designation	Type	Allowed values	V/ M	Processing rule
Districts of work (WorkMunicipalities)	wrfirt:WorkMunicipalities		V	Data groups or data items belonging to this data group and marked as voluntary are returned if they were submitted in the report, and are included in the data access profile used to query the record.
District of work (WorkMunicipality)	irct:String200		M	There may be several districts of work.



2.52 Address in country of work (WorkCountryAddress)

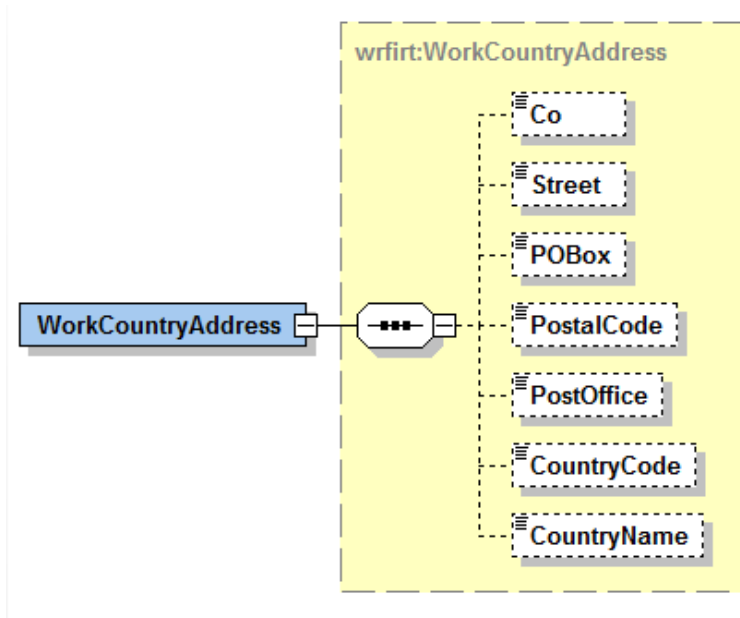

Data group details:

Data designation	Type	Allowed values	V/ M	Processing rule
Address in country of work (WorkCountryAddress)	wrfirt:WorkCountryAddress		V	Data groups or data items belonging to this data group and marked as voluntary are returned if they were submitted in the report, and are included in the data access profile used to query the record.
c/o (Co)	irct:String70		V	
Street address (Street)	irct:String100		V	
P.O. Box (POBox)	irct:String10		V	
Postal code (PostalCode)	irct:String20		V	
City (PostOffice)	irct:String200		V	

Data designation	Type	Allowed values	V/ M	Processing rule
Country code (CountryCode)	irct:String2	A two-character code in accordance with the ISO 3166 country codes. If the country is unknown, the value is "99".	V	
Country name (CountryName)	irct:String70		V	



2.53 Principal (ServiceRecipient)

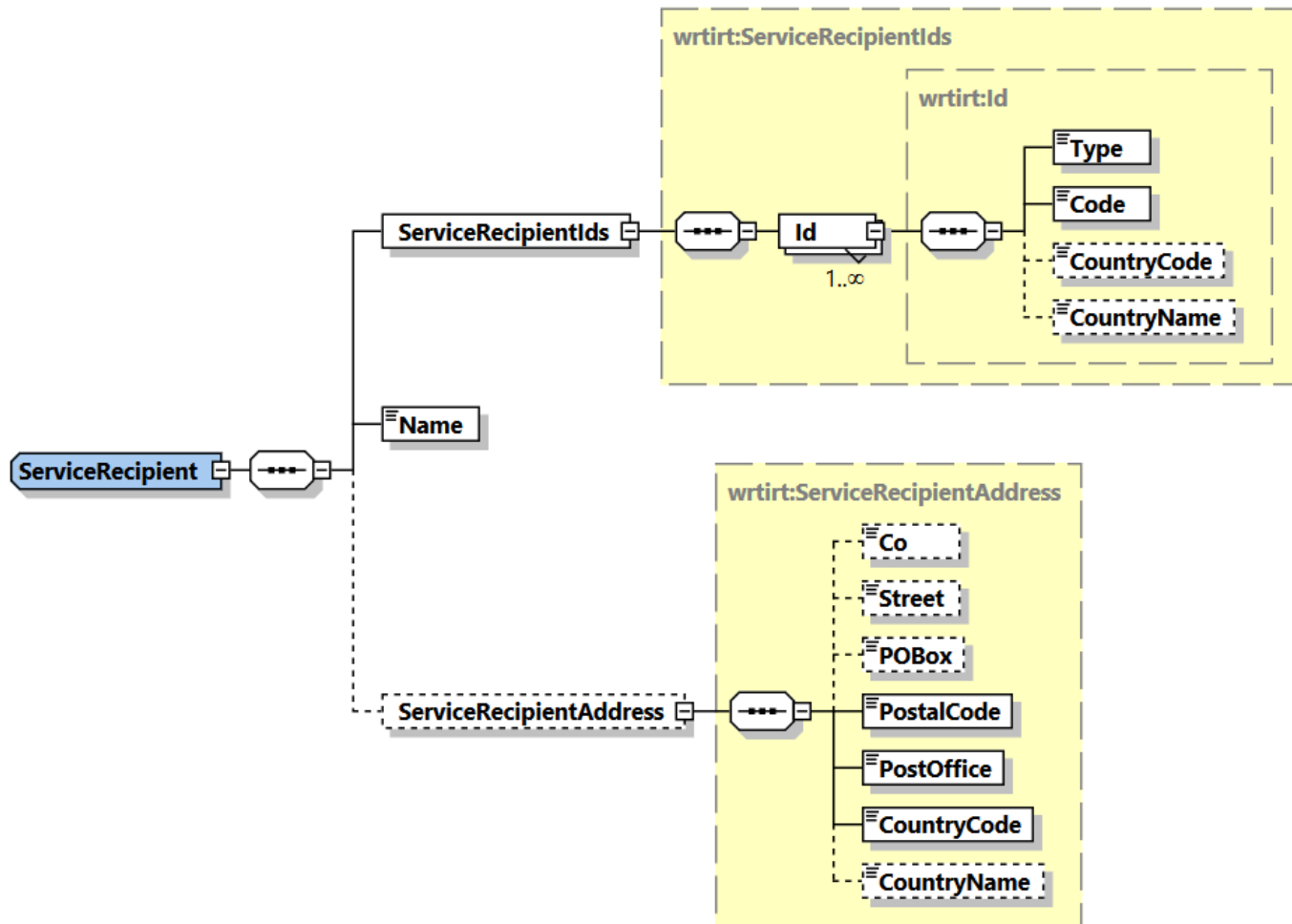

Data group details:

Data designation	Type	Allowed values	V/ M	Processing rule
Principal (ServiceRecipient)	wrfirt:ServiceRecipient		V	Data groups or data items belonging to this data group and marked as voluntary are returned if they were submitted in the report, and are included in the data access profile used to query the record.
Principal identifiers (ServiceRecipientIds)	wrfirt:ServiceRecipientIds		V	
Principal identifier (Id)	wrfirt:Id		M	A principal can have several identifiers.
Identifier type (Type)	xs:int	Codes: IdType	V	
Identifier (Code)	irct:String30		V	
Country code (CountryCode)	irct:String2	A two-character code in accordance with the ISO 3166 country codes. If the country is unknown, the value is "99".	V	
Country name (CountryName)	irct:String70		V	
Principal's name (Name)	irct:String200		V	
Principal's address (ServiceRecipientAddress)	wrfirt:ServiceRecipientAddress		V	Address information under an access restriction to personal data will not be shared.
c/o (Co)	irct:String70		V	
Street address (Street)	irct:String100		V	
P.O. Box (POBox)	irct:String10		V	
Postal code (PostalCode)	irct:String20		V	
City (PostOffice)	irct:String200		V	
Country code (CountryCode)	irct:String2	A two-character code in accordance	V	



Data designation	Type	Allowed values	V/ M	Processing rule
		with the ISO 3166 country codes. If the country is unknown, the value is "99".		
Country name (CountryName)	irct:String70		V	

2.54 Stay periods in country of work (StayPeriodsAbroad)

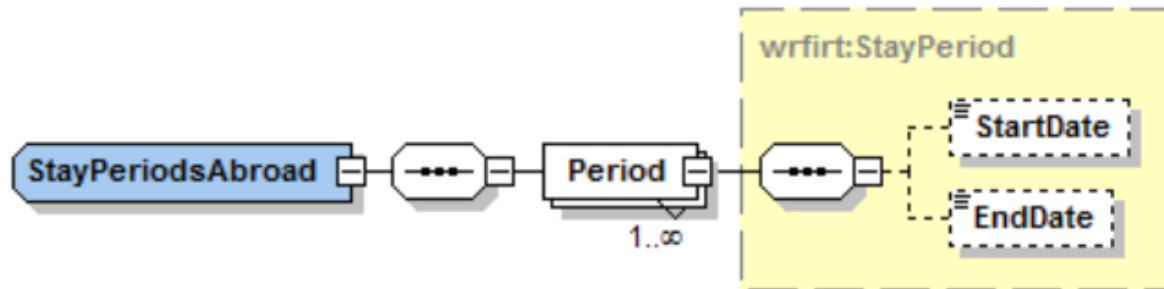

Data group details:

Data designation	Type	Allowed values	V/ M	Processing rule
Stay periods in country of work (StayPeriodsAbroad)	wrfirt:StayPeriodsAbroad		V	Data groups or data items belonging to this data group and marked as voluntary are returned if they were submitted in the report, and are included in the data access profile used to query the record.
Stay period in country of work (Period)	wrfirt:StayPeriod		M	There may be several stay periods in the country of work.
Start date (StartDate)	xs:date		V	
End date (EndDate)	xs:date		V	



2.55 Work periods abroad (WorkPeriodsAbroad)

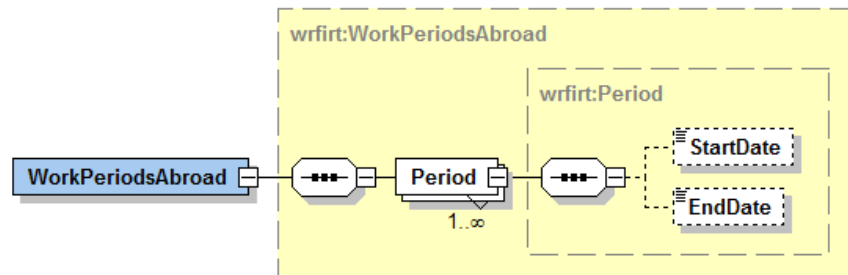

Data group details:

Data designation	Type	Allowed values	V/ M	Processing rule
Work periods abroad (WorkPeriodsAbroad)	wrfirt:WorkPeriods Abroad		V	Data groups or data items belonging to this data group and marked as voluntary are returned if they were submitted in the report, and are included in the data access profile used to query the record.
Work period abroad (Period)	wrfirt:Period		M	There may be several work periods abroad.
Start date (StartDate)	xs:date		V	
End date (EndDate)	xs:date		V	



2.56 Other remunerations and benefits (Remunerations)

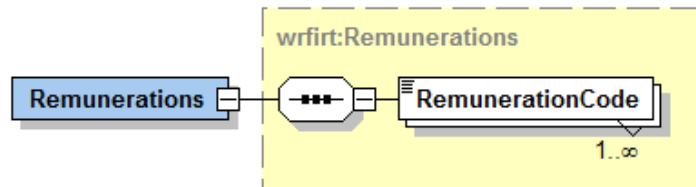

Data group details:

Data designation	Type	Allowed values	V/ M	Processing rule
Other remunerations and benefits (Remunerations)	wrfirt:Remunerations		V	Data groups or data items belonging to this data group and marked as voluntary are returned if they were submitted in the report, and are included in the data access profile used to query the record.
Benefit type (RemunerationCode)	xs:int	Codes: RemunerationCode	M	There may be several benefit types.



2.57 Absences (Absence)

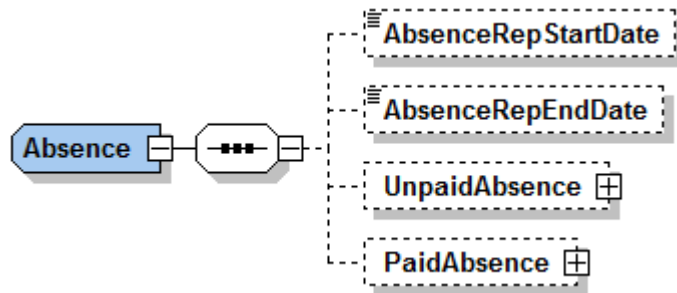

Data group details:

Data designation	Type	Allowed values	V/ M	Processing rule
Absences (Absence)	wrfirt:Absence		V	Data groups or data items belonging to this data group and marked as voluntary are returned if they were submitted in the report, and are included in the data access profile used to query the record.
Start date of the time period for reporting absences (AbsenceRepStartDate)	xs:date		V	
End date of the time period for reporting absences (AbsenceRepEndDate)	xs:date		V	
Unpaid absence (UnpaidAbsence)	wrfirt:UnpaidAbsence		V	
Paid absence (PaidAbsence)	wrfirt:PaidAbsence		V	



2.58 Unpaid absence (UnpaidAbsence)

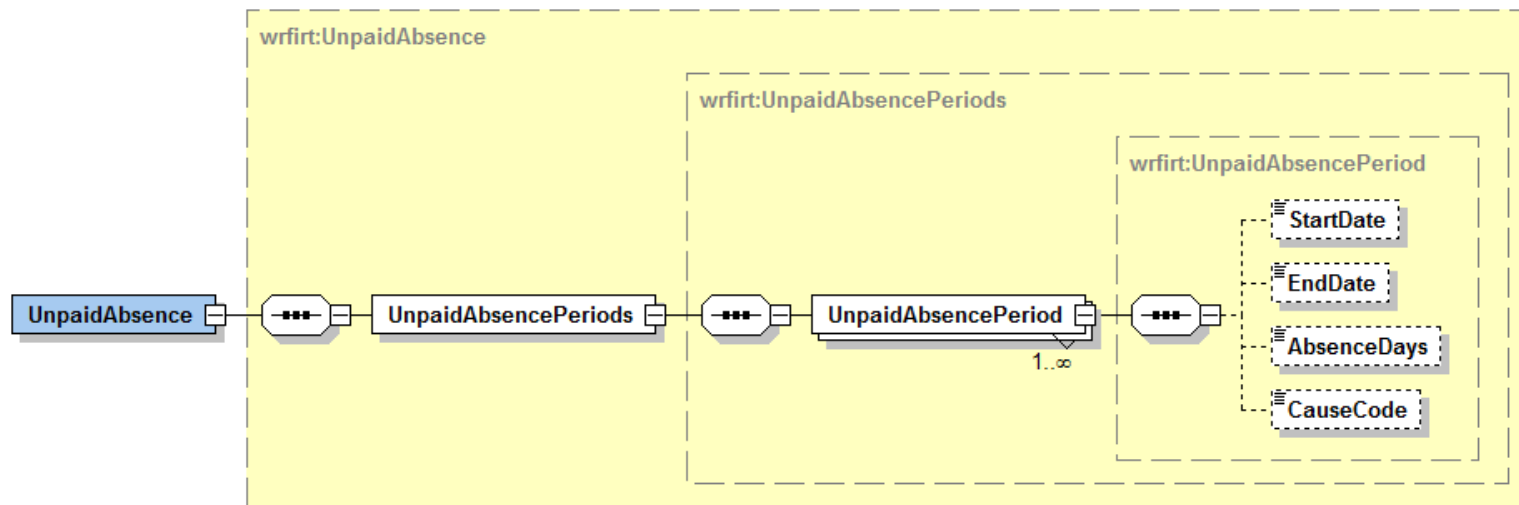

Data group details:

Data designation	Type	Allowed values	V/ M	Processing rule
Unpaid absence (UnpaidAbsence)	wrfirt:UnpaidAbsence		V	Data groups or data items belonging to this data group and marked as voluntary are returned if they were submitted in the report, and are included in the data access profile used to query the record.
Absence periods (UnpaidAbsencePeriods)	wrfirt:UnpaidAbsencePeriods		M	
Absence period (UnpaidAbsencePeriod)	wrfirt:UnpaidAbsencePeriod		M	There may be several absence periods.
Start date (StartDate)	xs:date		V	
End date (EndDate)	xs:date		V	

Data designation	Type	Allowed values	V/ M	Processing rule
Number of days of absence (AbsenceDays)	xs:int		V	
Cause of absence (CauseCode)	xs:int	Codes: UnpaidAbsenceCaus eCode	V	

2.59 Paid absence (PaidAbsence)

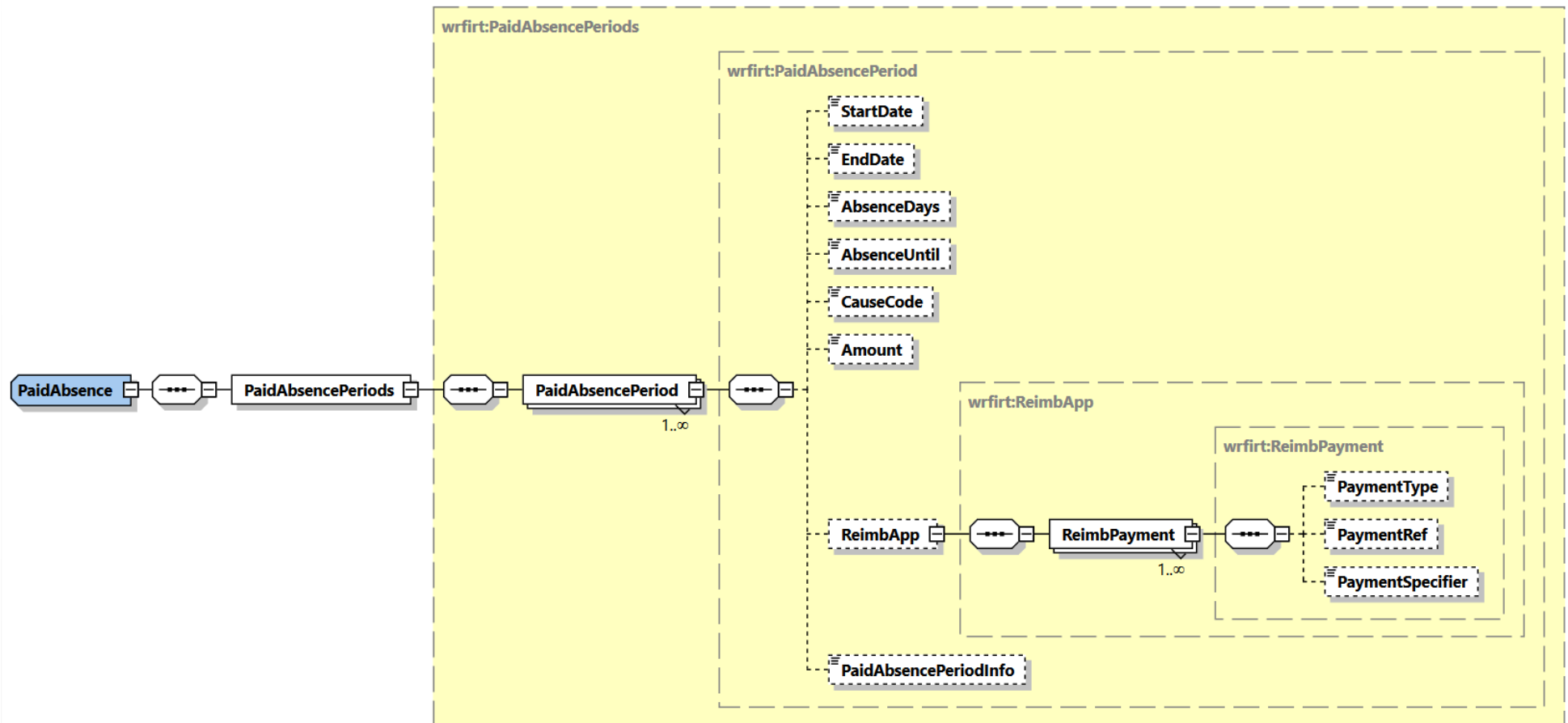

Data group details:

Data designation	Type	Allowed values	V/M	Processing rule
Paid absence (PaidAbsence)	wrfirt:PaidAbsence		V	Data groups or data items belonging to this data group and marked as voluntary are returned if they were submitted in the report, and are included in the data access profile used to query the record.
Absence periods (PaidAbsencePeriods)	wrfirt:PaidAbsencePeriods		V	
Absence period (PaidAbsencePeriod)	wrfirt:PaidAbsencePeriod		M	There may be several absence periods.
Start date (StartDate)	xs:date		V	
End date (EndDate)	xs:date		V	
Number of days of absence (AbsenceDays)	xs:int		V	
Absence continues, until when (AbsenceUntil)	xs:date		V	
Cause of absence (CauseCode)	xs:int	Codes: PaidAbsenceCauseCode	V	
Pay for period of paid absence (Amount)	irct:decimal2		V	
Reimbursement application data (ReimbApp)	wrfirt:ReimbApp		V	
Payment data (ReimbPayment)	wrfirt:ReimbPayment		M	There can be several payment data entries.
Payment data type (PaymentType)	xs:int	Codes ReimbPaymentType	V	
Payment's reference number (PaymentRef)	irct:String50		V	



Data designation	Type	Allowed values	V/M	Processing rule
Payment specifier (PaymentSpecifier)	irct:String200		V	
Additional reimbursement application data (PaidAbsencePeriodInfo)	irct:String850		V	